

Before you start

Precautions

FOR YOUR SAFETY (in Australia):
Install any external aerial to AS 1417.1

NOTE:
This unit can be used only where the power supply is AC 230–240V ~ ± 10%, 50Hz ± 0.5%. It cannot be used elsewhere.

CAUTION:
USE OF CONTROLS OR ADJUSTMENTS OR PERFORMANCE OF PROCEDURES OTHER THAN THOSE SPECIFIED HEREIN MAY RESULT IN HAZARDOUS RADIATION EXPOSURE.
AS THE LASER BEAM USED IN THIS UNIT IS HARMFUL TO THE EYES, DO NOT ATTEMPT TO DISASSEMBLE THE CABINET. REFER SERVICING TO QUALIFIED PERSONNEL ONLY.

WARNING:
TO REDUCE THE RISK OF FIRE OR ELECTRIC SHOCK, DO NOT EXPOSE THIS EQUIPMENT TO RAIN OR MOISTURE.

TO REDUCE THE RISK OF FIRE OR ELECTRIC SHOCK, AND ANNOYING INTERFERENCE, USE THE RECOMMENDED ACCESSORIES ONLY.

TO PREVENT FIRE OR SHOCK HAZARD, DO NOT EXPOSE THIS APPARATUS TO DRIPPING OR SPLASHING, NO OBJECTS FILLED WITH LIQUIDS, SUCH AS VASES, SHOULD BE PLACED ON THE APPARATUS.

Laser Diode Properties
Material: GaAs
Wave length: DVD: 658 nm
CD: 790 nm
Emission Duration: Continuous
Laser output: Max. 19 mW

- This unit is classified as a CLASS 1 LASER product.
- The CLASS 1 LASER PRODUCT marking is embossed on the rear cover.
- This product contains a low power laser device. To ensure continued safety, do not remove any cover or attempt to gain access to the inside of the product. Refer all servicing to qualified personnel.

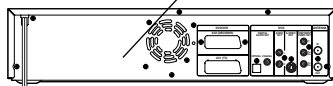
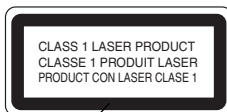

Power Cord Protection

To avoid any malfunctions of the unit, and to protect against electric shock, fire or personal injury, please observe the following.

- Hold the plug firmly when connecting or disconnecting the AC power cord.
- Keep the AC power cord away from heating appliances.
- Never put any heavy object on the AC power cord.
- Do not bundle any cables such as; AC power cord, Round Coaxial cable or other cables that are used to connect this unit to your TV together. Or never put any cables on the top panel of this unit. The noise or disturbance of the picture may be generated.
- Do not attempt to repair or reconstruct the AC power cord in any way.

Nonuse Periods

- When the unit is not being used, switch the unit to the standby mode.
- When left unused for a long period of time, the unit should be unplugged from the household AC outlet.

No Fingers or Other Objects Inside

Do not put your fingers or objects on the disc tray or in the cassette compartment.

Warning of Dew Formation

Moisture may form inside the unit under the following conditions:

- Immediately after a heater is turned on.
- In a steamy or humid room.
- When the unit is suddenly moved from a cold to warm environment. If moisture forms inside this unit, it may not operate properly or damage the video tape. In such case, turn on the power and wait for more than 2 hours for the moisture to evaporate.

Supplied Accessory

- Remote control with two AA (R6) size batteries

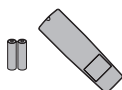

- Round Coaxial cable



- Video / Audio cable

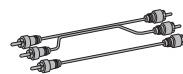

- Scart output adaptor

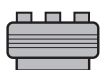

- Operation Manual



Before you start

Precautions (cont'd)

Location and Handling

- Do not stand the unit vertically. Install the unit in a horizontal and stable position. Do not place anything directly on top of the unit. Do not place the unit directly on top of the TV.
- Depending on the TV, noise or disturbance of the picture and/or sound may be generated if the unit is placed too close to your TV. In this case, please ensure enough space between your TV and the unit.
- Do not cover or place the unit in enclosed spaces to prevent excessive temperature build up.
- Keep the distances 20cm around apparatus of ventilation openings.
- Do not place the unit in direct sunlight, or near heat sources. Do not place any combustible objects on the device (candles, etc.).
- Depending on the environment, the temperature of the unit may increase slightly. This is not a malfunction.
- Keep the unit away from strong magnetic objects.
- Do not place any object containing water or other liquids on the unit. In the event that liquid should enter the cabinet, unplug the unit immediately and contact the retailer or service centre approved by SHARP immediately.
- Do not remove the unit cabinet. Touching parts inside the cabinet could result in electric shock and/or damage to the unit. For service and adjustment inside the cabinet, call a qualified dealer or service centre approved by SHARP.
- Be sure to remove a disc and unplug the AC power cord from the output before carrying the unit.
- Disconnect the mains plug to shut off when find troubles or not in use.
- The mains plug shall remain readily operable.
- Read both manual instructions to ensure correct and safe installation and interconnection of the unit in multimedia systems.

Copyright

Copyright may exist in material you wish to record. Copying such material without permission of the relevant licensee(s) or owner(s) of the copyright is prohibited by law. SHARP is not in a position to authorise the recording of copyright works and nothing in this manual should be read or implied as giving that authority.

Copy Protection

This unit supports Macrovision copy protection.

On DVD discs that include a copy protection code, if the contents of the DVD disc are copied using a VCR, the copy protection code prevents the videotape copy from playing normally.

U.S. Patent Nos. 4,631,603; 4,819,098; 4,907,093; 5,315,448; and 6,516,132.

This product incorporates copyright protection technology that is protected by U.S. patents and other intellectual property rights. Use of this copyright protection technology must be authorised by Macrovision, and is intended for home and other limited viewing uses only unless otherwise authorised by Macrovision. Reverse engineering or disassembly is prohibited.

- When attempting to record copy protected material on a VCR or other recording device, the copy protection will activate and the protected material will not be recorded correctly. In addition, attempting to display copy protected material on a monitor connected via a VCR, whether for the purpose of viewing or not, will cause an inferior quality picture to be displayed. This is not a fault of the equipment. Please view copy protected material by connecting the product directly to the monitor.

Manufactured under license from Dolby Laboratories. "Dolby" and the double-D symbol are trademarks of Dolby Laboratories.

Dolby Digital Recording

"Dolby® Digital Recording enables consumers to record high-quality video with stereo sound on recordable DVD discs. The technology, when utilized instead of PCM recording, also saves recordable disc space, allowing for higher video resolution or extended recording time on each DVD. DVDs created using Dolby Digital Recording will play back on all DVD-Video players."

Note: This is true when the players are compatible with actual recordable DVD discs.

"DTS" and "DTS Digital Out" are trademarks of Digital Theater Systems, Inc.

"Kodak Picture CD COMPATIBLE" is a trademark of Eastman Kodak Company.



DivX, DivX Certified, and associated logos are trademarks of DivX, Inc. and are used under license.

is a trademark of DVD Format/Logo Licensing Corporation.

Before you start

Precautions (cont'd)

Notice for Progressive Scan Outputs

Consumers should note that not all high definition television sets are fully compatible with this product and may cause artifacts to be displayed in the picture. In case of picture problems with 525 or 625 progressive scan output, it is recommended that the user switch the connection to the 'standard definition' output. If there are questions regarding your TV set compatibility with this 525p or 625p DVD player, please contact our customer service centre.

"Licensed under one or more of U.S. Pat. 4,972,484, 5,214,678, 5,323,396, 5,530,655, 5,539,829, 5,544,247, 5,606,618, 5,610,985, 5,740,317, 5,777,992, 5,878,080, or 5,960,037."

If There Is Noise Interference on the TV While a Broadcast Is Being Received

Depending on the reception condition of the TV, interference may appear on the TV monitor while you watch a TV broadcast and the unit is left on. This is not a malfunction of the unit or the TV. To watch a TV broadcast, turn off the unit.

Maintenance

SERVICING

1. Please refer to relevant topics in the "Troubleshooting" on page 91 before returning the product.
2. Do not attempt to service this unit yourself. Instead, unplug it and contact a SHARP Approved Service Centre for inspection.
3. Be sure the service technician uses authorised replacement parts or their equivalents. Unauthorised parts may cause fire, electrical shock, or other hazards.
4. Following any service or repair, be sure the service technician performs safety checks to certify that this unit is in safe operating order.

CLEANING THE CABINET

- Use a soft cloth slightly moistened with a mild detergent solution. Do not use a solution containing alcohol, spirits, ammonia or abrasive.

CLEANING DISCS

- When a disc becomes dirty, clean it with a cleaning cloth. Wipe the disc from the centre out. Do not wipe in a circular motion.
- Do not use solvents such as benzene, thinner, commercially available cleaners, detergent, abrasive cleaning agents or antistatic spray intended for analogue records.

RECOMMENDED MEASURES FOR OPTIMUM PICTURE EXCELLENCE

This unit is a precision device constructed using extremely accurate technology.

- The disc cannot be played if the disc drive component is worn out or if the internal pickup lens is dirty.
- If this unit still does not perform properly although you refer to the relevant sections and to "Troubleshooting" on page 91, the laser optical pickup unit may be dirty. Consult a SHARP Approved Service Centre for inspection and cleaning of the laser optical pickup unit.

Soiling or friction affecting the pickup lens or disc drive can impair the image quality. At the worst, neither video nor audio will be played back. To maintain optimum picture quality, the Player should be serviced (cleaned and replacement of some parts) every 1,000 hours. Note that this period varies depending on the environment (temperature, humidity, dust, etc.) in which the unit is used. Contact your authorised SHARP supplier for details.

DISC HANDLING

- When you handle a disc, hold it by its edge and try not to touch the surface of the disc.
- Always store a disc in its protective case when it is not used.

AUTO HEAD CLEANING

- Automatically cleans video heads as you insert or remove a cassette, so you can see a clear picture.
 - Playback picture may become blurred or interrupted while the TV programme reception is clear. Dirt accumulated on the video heads after a long period of use, or the usage of rental or worn tapes can cause this problem. If a streaky or snowy picture appears during playback, the video heads in your unit may need to be cleaned.
1. Please visit your local Audio/Video store and purchase a good quality VHS Video Head Cleaner.
 2. If a Video Head Cleaner does not solve the problem, please consult your dealer or an authorized service centre.

Note

- Remember to read the instructions along with the video head cleaner before use.
- Clean video heads only when problems occur.

For Customer Use:

Read carefully the information located at the bottom of your unit and enter below the Serial No. Retain this information for future reference.

Model No.: VCR/DVD RECORDER COMBINATION: DV-RW370X

Serial No.: _____

Before you start

Table of contents

Before you start	2	PBC function for Video CDs	48
Precautions	2	Playing back a Video CD using the Title menu	48
Table of contents	5	Cancelling and Recalling the PBC function	49
Features	6	Special playback	49
Symbols used in this Operation Manual	6	Resume playback	49
Functional overview	7	Fast forward / Fast reverse	50
Installing batteries in the remote control	10	Skipping TV commercials during playback	50
About the remote control	10	Pause	51
Child Lock function	10	Rapid Play	51
The VCR/DVD recorder Switching	11	Step by step playback	52
Guide to On-Screen Displays	11	Slow forward / Slow reverse playback	52
Connections	14	Zoom	53
Connecting to a TV	14	Marker Setup	53
Connecting to external equipment	15	Search	54
Connecting to an Audio System	16	Title / Chapter search	54
Getting started	17	Track search	54
Easy DVD recording	17	Direct Search	55
Channel setting	19	Time search	55
Auto Tuning	19	Repeat/Random/Programme playback / Slide Show	56
Manual Tuning	20	Repeat playback	56
To select a channel	21	Random playback	57
To skip a Preset channel	21	Programme playback	58
Move	21	Slide Show	58
Setting the clock	22	DivX® VOD	59
Clock Setting	22	Selecting the format of audio and video	59
Selecting the On-Screen Display (OSD) language	23	Switching subtitles	59
Selecting the TV aspect ratio	23	Switching audio soundtrack	60
Recording	24	Switching virtual surround system	60
Information on DVD recording	24	Switching camera angles	61
Type of discs	24	Reducing block noise	61
Recordable discs	24	Editing	62
Recording mode	24	Information on disc editing	62
Restrictions on recording	24	Guide to a title list	62
Information on copy control	25	Edit the recorded disc	62
Making discs playable in other DVD players (Finalise)	25	Editing discs	63
Usable discs	25	Notes for deleting titles	63
Formatting a disc	26	Editing discs	64
Choosing the recording format of a brand-new	26	Deleting titles	64
DVD-RW disc	26	Editing title names	65
Setting Auto Chapter	27	Guide to edit title name	66
Recording Audio Select (XP)	27	Adding or deleting chapter marks	67
Reformatting a disc manually	28	Setting pictures for thumbnails	69
Selecting the Sound mode	29	Deleting a part of a title	70
Setting External Input Audio	29	Dividing a title	72
Setting Bilingual Recording Audio	29	Combining titles	73
Basic recording / One-touch Timer Recording (OTR)	30	Adding titles to a Playlist	74
Timer Recording	31	Erasing all Playlist	75
Checking, cancelling, or correcting the timer programming	32	Setting or releasing the title protection	76
information	32	Setting or clearing all chapter marks in one title	77
To stop the timer recording in progress	32	Changing the Setup menu	78
If the timer programming did not complete correctly	32	Tour of the Setup menu	78
Hints for Timer Recording	33	Language setting	79
Satellite Link	34	Display setting	80
Settings for external equipment	35	Audio setting	81
Recording from external equipment	35	Video setting	83
DV dubbing	36	DVD-Videos Parental Lock level	85
Guide to DV and On-Screen Display	36	VCR functions	87
Dubbing Mode	38	Playback	87
Setting a disc to protect	40	Recording and One-touch Timer Recording (OTR)	87
Finalising discs	40	Basic Recording	87
Auto finalise	41	One-touch Timer Recording	88
Disc Playback	42	Search	89
Information on playing back DVDs	42	Index search	89
Playable discs	42	Time search	89
Colour systems	42	Other operations	90
Region codes	42	Hi-Fi Stereo Sound System	90
Playing back on DivX® file	42	Others	91
Basic playback	43	Troubleshooting	91
Hint for DVD playback	43	Language code	95
Playing back a DVD-RW / DVD-R / DVD+RW / DVD+R disc	43	Glossary	96
Playing back a DVD-Video / CD / Video CD	44	Specifications	97
Playing back an MP3 / JPEG	44		
Playing back a DivX®	45		
Playing back discs using the Disc menu	47		
Playing back a disc using the Title menu	48		

Before you start

Features

Recording

The unit is compatible with DVD-RW discs, which are recordable repeatedly, and DVD-R discs, which are recordable only once. Also, this unit allows you to record to the video cassette tape. You can choose either one for your convenience.

Recording up to 8 programmes: VCR MODE DVD MODE

You can programme the unit to record up to 8 programmes, up to a month in advance. Daily or weekly programme recordings are also possible.

One-touch Timer Recording:

You can set your required recording end time easily. Every time [VCR REC/OTR ●] or [DVD REC/OTR ●] is pressed during basic recording, the recording end time will be increased by 30 minutes up to 8 hours. The recording automatically stops when the recording time you set is finished.

Dubbing mode:

You can copy a DVD disc to a videotape or copy a videotape to a DVD disc. This function will be available only if the DVD disc and the videotape are not copy-protected.

Left channel stereo recording:

The unit can record monaural sound from the Left channel as pseudo stereo sound (same Left and Right channels) automatically. (This function is not available for input source of AV3 jacks on the front panel.)

Automatic Chapter marks setting: DVD MODE

Chapter marks will be added to recordings as you set them in the Setup menu before starting to record.

Automatic Title menu making (Video mode):

The unit creates Title menus automatically when finalising discs.

Automatic Playlist making (VR mode):

The unit creates a Playlist automatically after recording.

Automatic finalising (Video mode):

You can finalise discs automatically at the end of the disc space if you set this in the Setup menu.

Playback DVD MODE

Theatre surround sound:

When the unit is connected to an amplifier or a decoder compatible with Dolby Digital or DTS, you can enjoy theatre-quality surround sound from discs recorded with the surround sound system.

Quick search:

You can easily find the part you want to watch using the search function. Search for a desired point on a disc by title, chapter or time.

Playback from Original or a Playlist (VR mode):

You can play back titles using either the Original list or a Playlist.

Virtual Surround System:

You can enjoy stereophonic space through your exciting 2 channel stereo system.

Playing back on DivX® file:

The unit performs a DivX® file purchased through the official site of DivX® Video which is called DivX® Video-On-Demand (VOD) services, and recorded it on the DVD-RW/-R or CD-RW/-R.

Playing back on MP3, JPEG and Kodak Picture CD files:

You can enjoy MP3, JPEG and Kodak Picture CD files which are recorded on CD-RW/-R.

Quick search for what you want to watch: VCR MODE

You can easily find the part you want to watch using the Index or Time search functions. An index mark will be assigned at the beginning of each recording you make. For Time search function, you can go to a specific point on a tape by entering the exact amount of time you wish to skip.

Editing DVD MODE

Delete titles:

If the title is no longer you need, you can delete it from the disc. This is a useful method if you want to increase the capacity of DVD-RW discs.

Editing title names:

You can change the title name you prefer.

Add or delete chapter marks (DVD-RW only):

You can easily add chapter marks for easy editing.

Choose the picture for thumbnails (VR mode only):

You can select a picture for thumbnail at a point you like.

A scene delete from a title (VR mode only):

If the title has many commercials or the part you don't want, you can erase them from the title.

Making your own Playlist (VR mode, Playlist only):

While the Original list remains unchanged, you can edit titles as you prefer and create your own Playlist.

Divide title / Combine titles / Add titles / Erase all titles

Protecting titles (VR mode, Original only):

To avoid accidental editing or erasing of titles, the protect function is useful when set to "ON" in the Original list.

Compatibility DVD MODE

Playing back discs recorded in Video mode on any regular DVD player:

Discs recorded in Video mode can be played back on regular DVD players, including computer DVD drives compatible with DVD-Video playback. You will need to finalise the discs recorded in Video mode to play back in other DVD players.













* DVD-Video Format (Video mode) is a new format for recording on DVD-RW/-R discs that was approved by the DVD Forum in 2000. Adoption of this format is optional for manufactures of DVD playback devices and there are DVD-Video players, DVD-ROM drives and other DVD playback devices available that cannot play back DVD-RW/-R discs recorded in the DVD-Video Format.

Official DivX® Certified product

Plays all versions of DivX® video (including DivX®6) with standard playback of DivX® media files.

Symbols used in this Operation Manual

To show what recording mode or media type applies to each function, the following symbols appear at the beginning of each operating item.

Symbol	Description
	Description refers to VHS tapes Use only cassettes marked VHS (VHS _{REC}).
	Description refers to DVD-RW in Video mode
	Description refers to DVD-RW in VR mode
	Description refers to DVD-R in Video mode
	Description refers to DVD-Video discs
	*Description refers to DVD+RW discs
	*Description refers to DVD+R discs
	Description refers to DVD-RAM discs
	Description refers to Audio CDs
	Description refers to Video CDs
	Description refers to CD-RW/-R discs with MP3 files
	Description refers to CD-RW/-R discs with JPEG files, including Kodak Picture CD files
	Description refers to DVD-RW/-R and CD-RW/-R discs with DivX® files

* There may be a disc which cannot be used or played back.

Before you start

Functional overview

Front Panel

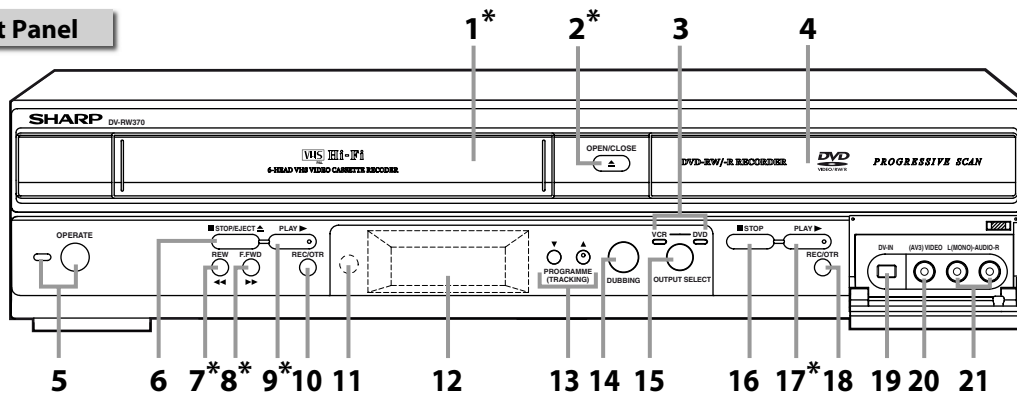

* ... You can also turn on the unit by pressing these buttons or insert a tape.

1 Cassette compartment* (VCR)

- Insert a tape here.

2 OPEN/CLOSE ▲ button* (DVD)

- Press to open or close the disc tray.

3 OUTPUT indicators (VCR / DVD)

- Indicates the selected component (VCR or DVD).

4 Disc tray (DVD)

- Place the disc here when open.

5 OPERATE button

- Press to turn on or off the unit.
- Red LED lights up when power is ON.
- If timer programming is set, press to switch the unit to timer-standby mode.

6 STOP ■/EJECT ▲ button (VCR)

- In stop mode, press to remove the tape from the unit.
- Press to stop the tape motion.
- Press to stop a timer recording of VCR.

7 REW ◀◀ button* (VCR)

- Press to rewind the video tape.
- Press to view the picture rapidly in reverse during the playback mode. (Rewind Search)
- Press to turn the unit on when the video tape is inserted and start rewinding the tape.

8 F.FWD ▶▶ button* (VCR)

- Press to rapidly advance the video tape.
- Press to view the picture rapidly in forward during playback. (Forward Search)
- Press to turn the unit on when the video tape is inserted and start rapidly advancing the tape.

9 PLAY ▶ button* (VCR)

- Press to start playback.

10 REC/OTR button (VCR)

- Press once to start a basic recording.
- Press repeatedly to set the One-touch Timer Recording.

11 Remote control sensor

- Receives signals from your remote control so you can control the unit from a distance.

12 Display (VCR / DVD)

- Refer to "Front Panel Display Guide" on page 13.

13 PROGRAMME (TRACKING) ▼ / ▲ buttons (VCR / DVD)

- Press to change the channel up or down.
- Press to adjust the tracking manually during VCR playback.

14 DUBBING button (VCR / DVD)

- Press to start VCR to DVD (DVD to VCR) duplication which you set in the Setup menu.

15 OUTPUT SELECT button (VCR / DVD)

- Press to select the DVD mode or the VCR mode.

16 STOP ■ button (DVD)

- Press to stop playback or recording.
- Press to stop a timer recording of DVD.

17 PLAY ▶ button* (DVD)

- Press to start or resume playback.

18 REC/OTR button (DVD)

- Press once to start a basic recording.
- Press repeatedly to set the One-touch Timer Recording.

19 DV-IN input jack (AV4) (VCR / DVD)

- Use to connect the DV output of external equipment with a DV cable.

20 VIDEO input jack (AV3) (VCR / DVD)

- Use to connect external equipment with a standard Video cable.

21 AUDIO input jacks (AV3) (VCR / DVD)

- Use to connect external equipment with a standard Audio cable.

Button names described in the Operation Manual

The instructions in this manual are described mainly with the operations using the remote control. Some operations can be carried out using the buttons on the front panel.

Before you start

Functional overview (cont'd)

Rear Panel

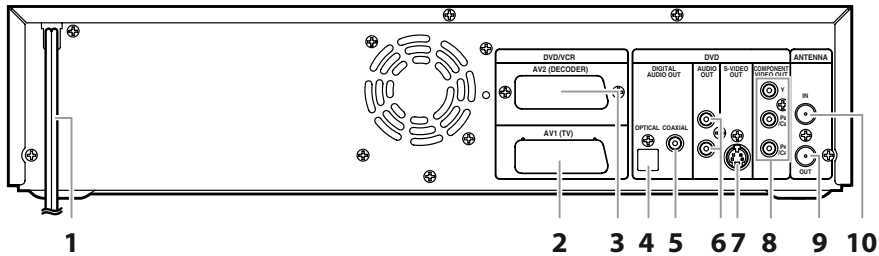

- 1 Mains cable**
 - Connect to a standard AC outlet.
- 2 AV1 (TV) Scart terminal (VCR / DVD)**
 - Connect to the Scart terminal on your TV.
 - Use the supplied Scart output adaptor with the Video / Audio cables if your TV has no Scart terminal.
- 3 AV2 (DECODER) Scart terminal (VCR / DVD)**
 - Connect to the Scart terminal of VCR, camcorder, or other Audio-Video equipment. Use a commercially available Scart cable.
- 4 DIGITAL AUDIO OUT (OPTICAL) jack (DVD)**
 - Connect to an amplifier with a digital input jack such as a Dolby Digital decoder, DTS decoder or MPEG decoder.
 - Use a commercially available Optical cable.
- 5 DIGITAL AUDIO OUT (COAXIAL) jack (DVD)**
 - Connect to an amplifier with a digital input jack such as a Dolby Digital decoder, DTS decoder or MPEG decoder.
 - Use a commercially available Coaxial cable.
- 6 AUDIO OUT (ANALOG) jacks (DVD)**
 - Connect to the audio input jacks on your TV. Use a commercially available Audio cable.
- 7 S-VIDEO OUT jack (DVD)**
 - Connect to the S-Video input jack on your TV. Use a commercially available S-Video cable.
- 8 COMPONENT VIDEO OUT jacks (DVD)**
 - Connect to the component video input jacks on your TV.
 - Use a commercially available Component video cable.
- 9 ANTENNA OUT jack (VCR / DVD)**
 - Connect to the Aerial jack on your TV, cable box or direct broadcast system.
 - Use the supplied Round Coaxial cable.
- 10 ANTENNA IN jack (VCR / DVD)**
 - Connect to an antenna or cable.

Note





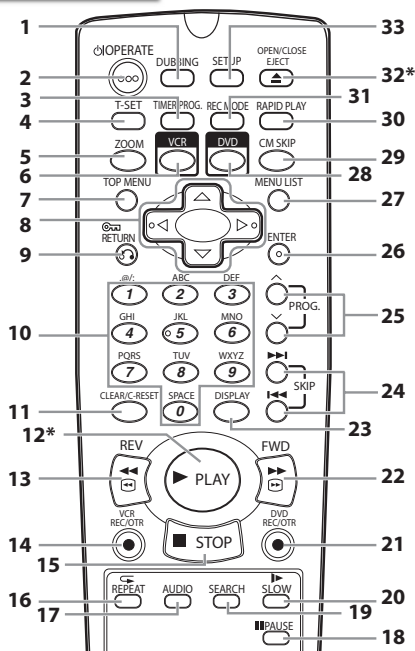













- Do not touch the inner pins of the jacks on the rear panel. Electrostatic discharge may cause permanent damage to the unit.
- This unit does not have an RF modulator.

Remote Control



* ... You can also turn on the unit by pressing these buttons when the remote control is in DVD mode.

- 1 DUBBING button (VCR / DVD)**
 - Press to start VCR to DVD (DVD to VCR) duplication which you set in the Setup menu.
- 2 OPERATE button (VCR / DVD)**
 - Press to turn on or off the unit.
 - If timer programming is set, press to switch the unit to the timer-standby mode.
- 3 TIMER PROG. button (VCR / DVD)**
 - Press to display the timer programme setting menu.
- 4 T-SET button (VCR / DVD)**
 - Press to enter the timer-standby mode. In the timer-standby mode, press to cancel the mode and to turn on the unit.
- 5 ZOOM button (DVD)**
 - During playback, press to enlarge the picture on the screen.
- 6 VCR button**
 - Press to activate the remote control in VCR mode. (See page 11.)
 - Press to select the VCR output mode.
- 7 TOP MENU button (DVD)**
 - Press to display the Title menu.
- 8 Cursor ▲ / ▼ / ◀ / ▶ buttons (VCR / DVD)**
 - Press to select items or settings.

- 9 RETURN**  /  button (VCR / DVD)
- Press to return to the previously displayed menu screen.
 - Press and hold it for more than 5 seconds to protect any operations both the unit and the remote control.
- 10 Number buttons** (VCR / DVD)
- Press to select channel numbers.
 - Press to select a title / chapter / track on the display. (DVD)
 - Press to enter values for settings in the Setup menu.
 - Press to enter the number in the Index or Time search in VCR mode.
 - Press to enter the characters in edit function. (DVD)
- 11 CLEAR/C-RESET button** (VCR / DVD)
DVD mode
- Press to clear the password once entered.
 - Press to cancel the programming for a disc.
 - Press to clear the selecting marker number in the marker setup mode.
 - Press to clear the programme once entered in the Timer Programming list.
- VCR mode**
- Press to reset the tape counter.
- 12 PLAY**  button* (VCR / DVD)
- Press to start or resume playback.
- 13 REV**  /  button (VCR / DVD)
DVD mode
- During playback, press to reverse fast.
 - When playback is paused, press to reverse slowly.
- VCR mode**
- Press to rewind the video tape.
 - Press to view the picture rapidly in reverse during the playback mode.
- 14 VCR REC/OTR**  button
- Press once to start a basic recording.
 - Press repeatedly to set the One-touch Timer Recording.
 - Press to activate the remote control in VCR mode. (See page 11.)
- 15 STOP**  button (VCR / DVD)
- Press to stop playing back or recording.
- 16 REPEAT**  button (DVD)
- Press to display the repeat playback menu.
- 17 AUDIO button** (VCR / DVD)
DVD mode
- When receiving a bilingual broadcast, press to change the audio out setting to "Main", "Sub", and "Main / Sub".
 - Press to change the bilingual audio source of an external equipment to "Main", "Sub", or "Main/Sub". (Available only when the "External Input Audio" in the DVD setup menu is set to "Bilingual" in advance.)
 - Press to display the audio menu during playback.
 - Press to select the sound mode.
- VCR mode**
- During playback of a Hi-Fi video tape, press to change the audio out setting to "STEREO", "LEFT", "RIGHT", and "MONO".
 - When receiving a bilingual broadcast, press to change the audio out setting to "Main", "Sub", and "Main/Sub".
 - Press to change the bilingual audio source of an external equipment to "Main", "Sub", or "Main/Sub". (Available only when the "External Input Audio" in the Setup menu is set to "Bilingual" in advance.)
- 18 PAUSE**  button (VCR / DVD)
- Press to pause playback or recording.
- 19 SEARCH button** (VCR)
- Press to call up the index or time search menu.
- 20 SLOW**  button (VCR)
- During playback, press to view the video tape in slow motion.
- 21 DVD REC/OTR**  button
- Press to activate the remote control in DVD mode. (See page 11.)
 - Press once to start a basic recording.
 - Press repeatedly to set the One-touch Timer Recording.
- 22 FWD**  /  button (VCR / DVD)
DVD mode
- During playback, press to forward fast.
 - When playback is paused, press to forward slowly.
- VCR mode**
- Press to rapidly advance the video tape.
 - Press to view the picture rapidly in forward during playback.
- 23 DISPLAY button** (VCR / DVD)
- Press to display the On-Screen Display.
- 24 SKIP**  button (DVD)
- During playback, press to skip to the previous chapter or track.
 - When playback is paused, press to play reverse step by step.
- SKIP**  button (DVD)
- During playback, press to skip to the next chapter or track.
 - When playback is paused, press to advance step by step.
- 25 PROG.**  /  buttons (VCR / DVD)
DVD mode
- Press to change the channel up or down.
- VCR mode**
- Press to change the channel up or down.
 - Press to adjust the tracking during playback or in slow motion of the tape.
 - While playback is in still mode, you can adjust the vertically blurred picture.
- 26 ENTER button** (VCR / DVD)
- Press to confirm or select menu items.
- 27 MENU LIST button** (DVD)
- Press to display the Disc menu during playback.
 - Press to change the Original and Playlist on the TV screen. (VR mode only)
- 28 DVD button**
- Press to activate the remote control in DVD mode. (See page 11.)
 - Press to select the DVD output mode.
- 29 CM SKIP button** (DVD)
- During playback, press to skip 30 seconds. (See page 50.)
- 30 RAPID PLAY button** (DVD)
- During playback, press to playback in a slightly faster/slower speed with keeping the audio quality.
- 31 REC MODE button** (VCR / DVD)
- Press to switch the recording mode.
- 32 OPEN/CLOSE EJECT**  button* (VCR / DVD)
- Press to open or close the disc tray.
 - Press to remove the tape from the unit.
- 33 SETUP button** (VCR / DVD)
- Press to display the Setup menu in stop mode.

Note

- Letters printed in blue are buttons effective only in VCR mode.

Before you start

Functional overview (cont'd)

Installing batteries in the remote control

Install two AA (R6) size batteries (supplied) into the remote control, carefully match with the polarity indicated inside the battery compartment.

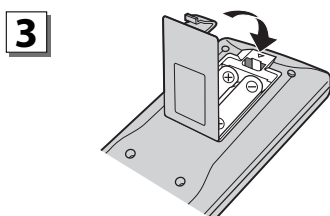
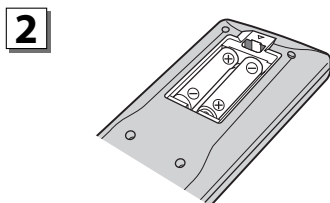
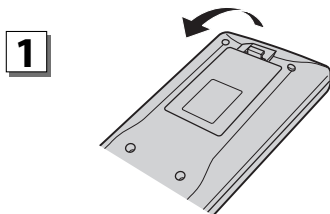

Caution

- Incorrect use of batteries can result in hazards such as leakage and bursting.
- Do not mix new and old batteries together.
- Do not use different kinds of batteries together.
- Make sure that the plus and minus ends of each battery match the indications inside the battery compartment.
- Remove batteries if the equipment will not be used for a month or more.
- When disposing used batteries, please comply with governmental regulations or the public instructions for environmental protection that apply in your country or area.
- Do not recharge, short-circuit, heat, burn or disassemble batteries.
- Comply with the rules (ordinance) of each local government when disposing of worn-out batteries.

About the remote control

- Make sure there is no obstacle between the remote control and the remote control sensor on the unit.
- Use within the operating range and angle as shown.
- The maximum operable range as follows:

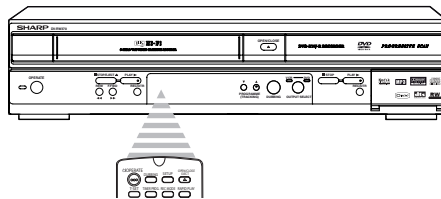

- Line of sight:** approximately 7m
- Either side of centre:** approximately 5m within 30 degrees
- Above:** approximately 5m within 15 degrees
- Below:** approximately 3m within 30 degrees

- Remote control operation may become unreliable if the remote control sensor of the unit is being exposed by the strong sunlight or fluorescent light.
- Remote controls for different devices can interfere with each other. Be careful when using remote controls for other equipment located close to the unit.
- Replace the batteries when the operating range of the remote control reduces.

Child Lock function

This function protects any unexpected operations by the kids when recording important programme and so on.

1

Press and hold [RETURN] (⏪ / ⏩) for more than 5 seconds.

"LOC" will be displayed on the front panel display and the Child lock is now activated.



- If any buttons (except for [RETURN] (⏪ / ⏩)) on the remote control or the unit are pressed, "⊘" will appear on the TV screen.

2

Press [RETURN] (⏪ / ⏩) again for more than 5 seconds.

"LOC" disappears and the Child lock will be released.

Note

- When One-touch Timer Recording or Timer Recording has finished or if the power failure occurs during Child lock is activated, the function will be released.

Before you start

Functional overview (cont'd)

The VCR/DVD recorder Switching

Because this product is a combination of a VCR and a DVD recorder, you must select first which component you wish to operate with **[OUTPUT SELECT]** on the front panel.

VCR MODE

Press **[VCR]** on the remote control.
(Verify that the VCR OUTPUT indicator is lit.)

DVD MODE

Press **[DVD]** on the remote control.
(Verify that the DVD OUTPUT indicator is lit.)

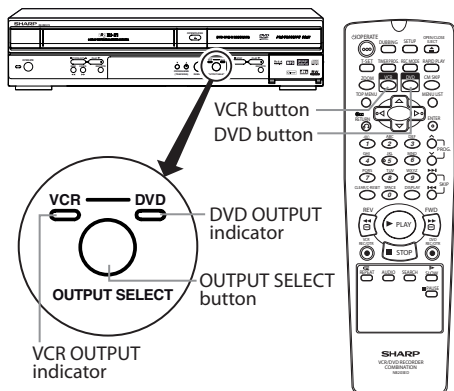

Note

- Press **[OUTPUT SELECT]** to select the VCR mode or the DVD mode.
- **Pressing only [OUTPUT SELECT] on the front panel DOES NOT switch the mode of the remote control. You MUST select the correct mode on the remote control.**
- You cannot switch to the mode (VCR or DVD) that is in the timer-standby mode.
- If the media is available, you can start recording by pressing **[VCR REC/OTR ●]** or **[DVD REC/OTR ●]** on the remote control even if another equipment (VCR or DVD) is selected. In this case, the mode of the remote control will be automatically switched to the appropriate component.
- In the wrong mode, the unit does not respond to your commands correctly. Before starting your desired operation, select the correct mode by following the instruction (Press first. or Press first.) of under the subject heading.

Guide to On-Screen Displays

DISPLAY menu

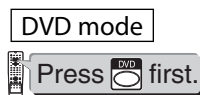

With a disc inserted into the unit, press **[DISPLAY]** to display the On-Screen Display. The menu shows information about what is recorded on the disc.

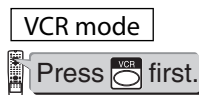
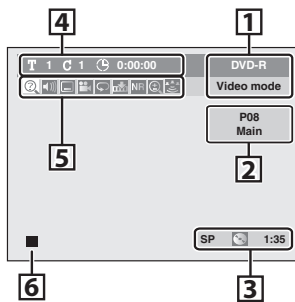

Press **[DISPLAY]** to display the On-Screen display.

While in the VCR mode, the On-Screen Display of the VCR mode is displayed.

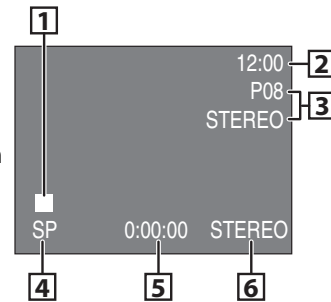

1 Disc type and format mode

In some descriptions in this manual, only one type of disc is indicated as an example.

2 Position number and an audio status of the programme

3 Recording mode and remaining time

4 Title number, chapter number and the time lapse of disc playback

5 Each icon means:

- | | |
|--------------------------|-------------------|
| : Search | : Marker |
| : Audio | : Noise Reduction |
| : Subtitle | : Zoom |
| : Angle (except VR mode) | : Surround |
| : Repeat | |

6 Status of the current disc

1 Status of the current tape

2 Current time

3 Current position number and an audio status of the receiving broadcast or external equipment

4 Recording or playing back mode

5 Tape Counter

6 Audio status of the currently playing back video tape

Note

- This is an example screen for explanation. Displayed items are depending on the actual mode.

Before you start

Functional overview (cont'd)

Setup menus

Press **[SETUP]** to display the Setup menu, then press **[ENTER]** to display each menu, using **[Cursor ▲ / ▼]**. These menus provide entries to all main functions of the unit.

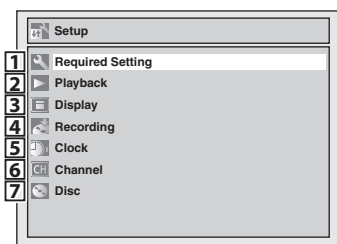

1 Required Setting:

To set up the required setting.

2 Playback:

To set up the unit to play discs as you prefer.

3 Display:

To set up the OSD screen and the front display of the unit as you prefer.

4 Recording:

To set up the unit to record on discs as you prefer.

5 Clock:

To set up the clock of the unit as you need.

6 Channel:

To adjust the channel setting of the unit as you prefer.

7 Disc / CD Playback Mode:

When a DVD-Video (commercially available), a brand new DVD-R disc or a DVD-RW/-R disc with DivX® files is inserted into the unit, you cannot select "Disc".

"CD Playback Mode" is available only when an Audio CD, Video CD or a CD-RW/-R disc with MP3 or JPEG files is inserted into the unit. You cannot select "CD Playback Mode" when CD-RW/-R disc with DivX® files is inserted into the unit.

<DVD-RW / DVD-R (Video mode)>

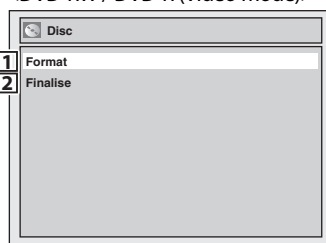

<DVD-RW (VR mode)>

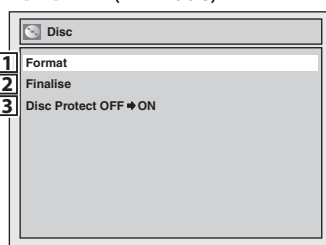

<CD / Video CD / MP3 / JPEG / KODAK PICTURE CD>

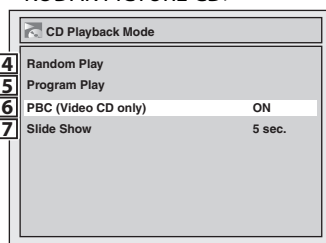

1 Format (DVD-RW only):

Allows you to erase all of the recorded content on the disc. The disc will be completely blank.

- Erased content cannot be called back.
- A DVD-RW disc formatted with this unit cannot be used on other DVD recorders without any recording using this unit.
- If you want to use a disc only formatted with this unit on another DVD recorder, you have to re-format the disc on that recorder.

2 Finalise:

Allows you to finalise a disc containing recorded titles.

3 Disc Protect (VR mode only):

Allows you to protect a disc from accidental editing or recording.

4 Random Play:

To activate the random playback feature.

5 Program Play (Audio CD / Video CD without PBC function):

To activate the programmed playback feature.

6 PBC (Video CD only):

Turn the PBC function "ON" or "OFF".

7 Slide Show (JPEG / KODAK PICTURE CD files only):

Select the display time of the slide show mode.

Note

- This is an example screen only for explanation. Displayed items are depending on the disc you inserted.

Before you start

Functional overview (cont'd)

Front Panel Display Guide

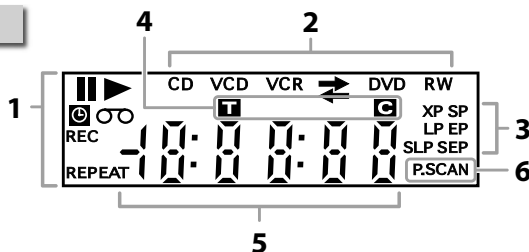

1. Current Status of the unit

- ||** : Appears when disc playback is paused. Appears also during step by step playback.
- ▶** : Appears when playing back a disc.
- ||▶** : Appears during slow forward or slow reverse playback.
- ⌚** : Appears when the timer programming or One-touch Timer Recording (OTR) is set and is operating. Appears when the unit goes into the Satellite Link standby mode. Flashes when all the timer programmes are finished. Flashes when there is an error in programming.
- REC** : Appears when recording. Flashes when recording being paused.
- REPEAT** : Appears during repeat playback. (only for disc playback)
- ⊖** : Appears when a tape is in the unit.

2. Disc type and Current status of the unit

- CD** : Appears when an Audio CD or a CD-RW/-R disc is inserted into the unit.
- VCD** : Appears when a Video CD is inserted into the unit.
- DVD** : Appears when a DVD / DivX® is inserted into the unit, or when recording or the timer-standby mode.
 - : Flashes when switch to the timer-standby mode while programming cannot set.
 - : Flashes when a programme cannot be performed for some reasons.
- DVD RW** : Appears when a DVD-RW disc is inserted into the unit.

- DVD R** : Appears when a DVD-R disc is inserted into the unit.
- VCR** : Appears when the Timer Recording is proceeding in VCR.
 - : Appears when VCR is in the timer-standby mode.
 - : Flashes when switch to the timer-standby mode while programming cannot set.
 - : Flashes when a programme cannot be performed for some reasons.
- VCR → DVD** : Appears during VCR to DVD duplication process.
- VCR ← DVD** : Appears during DVD to VCR duplication process.

3. Recording mode

- Selected recording mode appears.

4. Title / Track and Chapter mark

- T** : Title / track number
- C** : Chapter number

5. Displays the following

- Playing back time
- Current title / chapter / track number
- Recording time / remaining time
- Clock
- Channel number
- VCR tape counter
- One-touch Timer Recording (OTR) remaining time

- 6. P.SCAN** : Appears when the progressive scan system is activated.

Display message



The unit is turning on.



The unit is turning off.



The disc tray is opening.



The disc tray is closing.

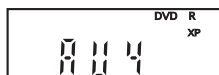

The DV input is selected.



The unit is loading a disc.

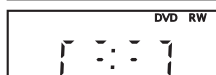

Data is being recorded on a disc.



The PBC function of the Video CD is activated.



The Satellite Link is activated.



The unit is protecting by the Child lock.

Connections

Connecting to a TV

- Be sure to turn off the unit and equipment to be connected before connecting.
- Read through the Operation Manual for the equipment to be connected.
- Be sure to keep the unit connection cables separate from the TV antenna cable when you install the unit, because it may cause electrical interference when you are watching television programmes.

Basic TV connection

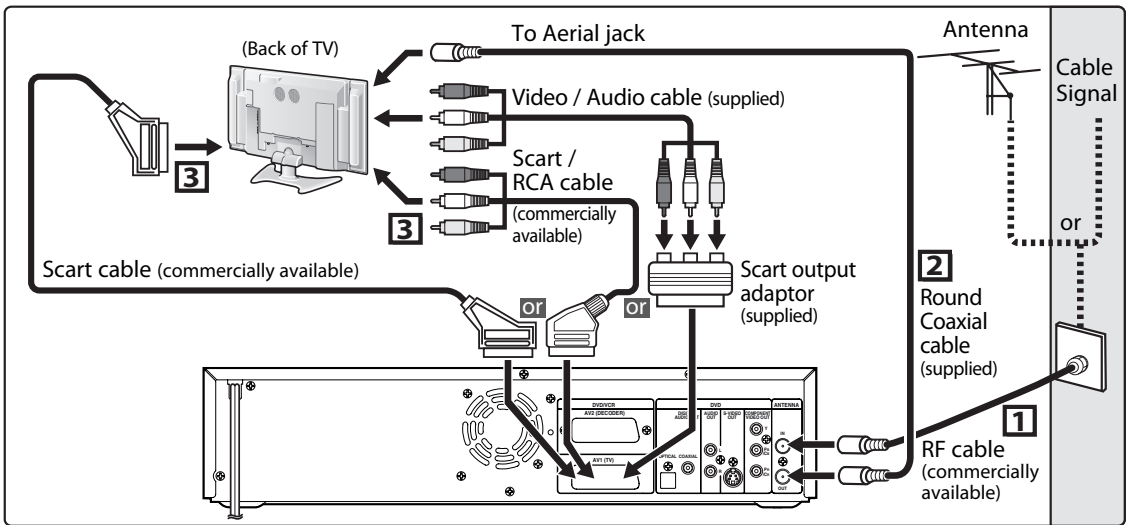

CAUTION:

- Connect the unit directly to the TV. Do not connect the unit to a VCR, then connect the VCR to the TV. Copyright protection in the VCR could distort the picture playing on the unit.

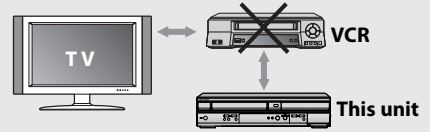

Note

- Playback picture from DVD cannot be delivered through the Round Coaxial cable. The Round Coaxial cable is only for sending the antenna signal to the TV.
- Connect the unit directly to the TV.
- If you attempt to view video on a TV connected via a VCR, the copy protection function will scramble the picture.

VCR and Basic DVD Connection

Available on DVD only

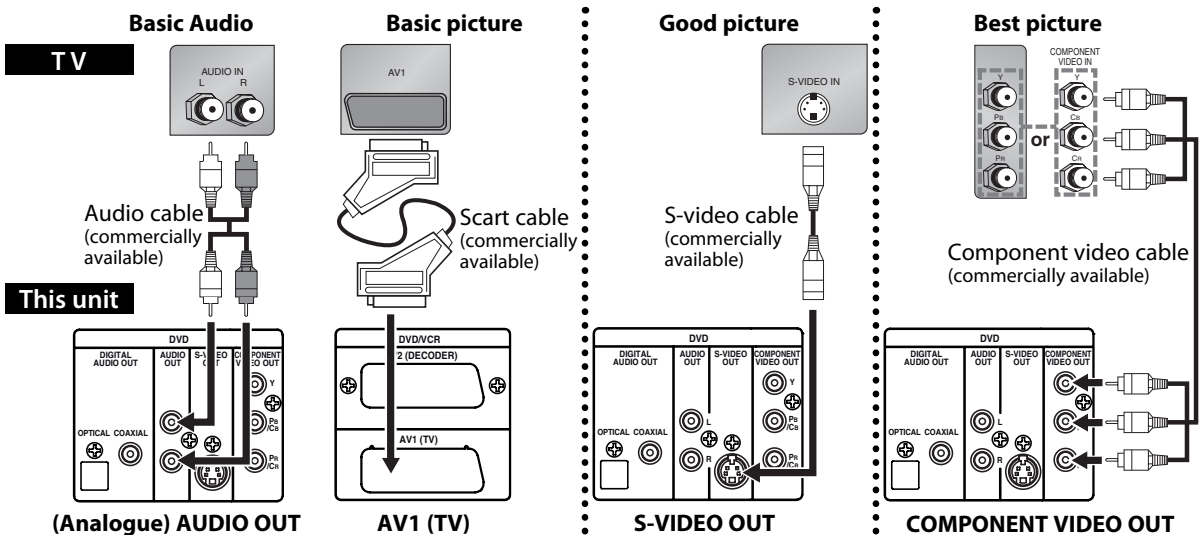

* Only if your TV accepts an RGB video signal.

Connections

Connecting to a TV (cont'd)

Note

- The unit is sending each video signals simultaneously. If you connected an S-VIDEO OUT and/or a COMPONENT VIDEO OUT with the VIDEO OUT (SCART), make sure your TV's input mode is set correctly according to the connection you made.
- You will not be able to hear all of the sound being output by the unit if you use the Audio cables (commercially available) to a monaural TV that has only one Audio input jack.
- Be sure that the colours of the jacks and plugs match up when connecting the cable.
- If you want to listen to the audio through audio equipment, connect only the S-video or Component video cable to the TV.
- The S-VIDEO OUT and COMPONENT VIDEO OUT jacks are only useful in DVD mode.
- If your TV is compatible with 525 or 625 progressive scanning and you want to enjoy that high quality picture, you must connect the Component video cable to your TV's component Video input jacks (Y/PR/PB) and select progressive scanning mode. To set the mode, set "Video Out" to "Component Progressive (P)" in the "Video" of the "Playback" menu so that "P.SCAN" will appear on the display of this unit. See pages 83-84 for more details.
- If your TV is not compatible with progressive scanning, use this unit in interlace mode. Make sure that no "P.SCAN" is on the display of this unit. If so, set "Video Out" to "Component Interlace (I)" in the "Video" of the "Playback" menu so that "P.SCAN" on the display of this unit will disappear.
- (Analogue) AUDIO OUT jacks and Scart terminal are not available on the DTS audio.

Connecting to external equipment

This unit has four input terminals, AV1 or AV2 on the rear panel and AV3 or AV4 on the front panel. Be sure that all the units are off before making connections.

Recording from a DVD player, VCR or other Audio-Video equipment with a Scart terminal (AV2)

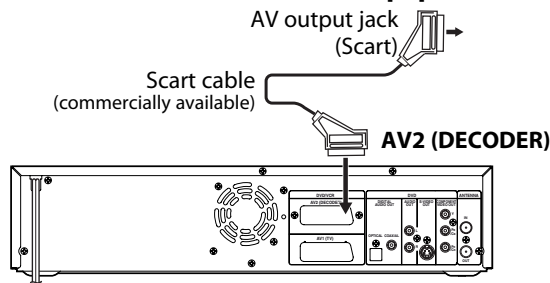

Note

- If the external equipment connected to the Scart terminal (AV2) supplies control voltage to this unit via Pin 8 of the Scart cable, the display functions of the remote control cannot be seen on the TV. In this case, turn off the external equipment to prevent control voltage, or make sure to use a Scart cable without Pin 8 for this connection.
- The AV2 (DECODER) connection is useful for playing back the picture only. Even if an external equipment such as a DVD player can be delivered an RGB signals and your TV accepts them, this unit only records a Composite video signal.

Recording from a camcorder or other Audio-Video equipment with no Scart terminal (AV3 or AV4)

Connect to VIDEO input jack by using an RCA Video cable or DV input jack by using DV cable. Those jacks are on the front panel.

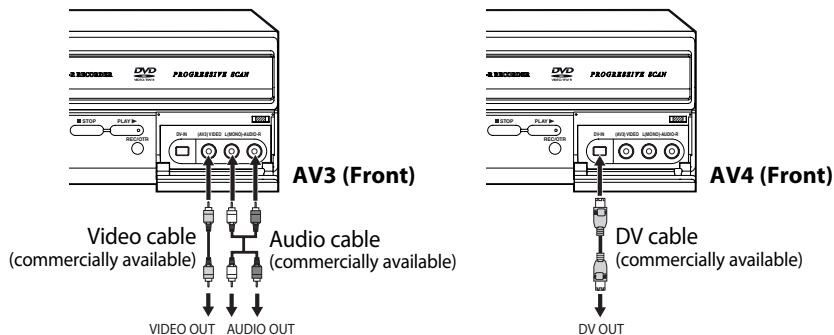

Note

- If you prefer better picture quality for the recordings from the external equipment, DV connections such as AV4 (front) is recommended.

Connections

Connecting to an Audio System

Playing 2 channel audio

Connecting the unit to audio equipment provides normal stereo sound, plus powerful stereo sound enhanced by Dolby Digital 5.1 channel surround sound, DTS and MPEG audio.

AUDIO

Stereo system

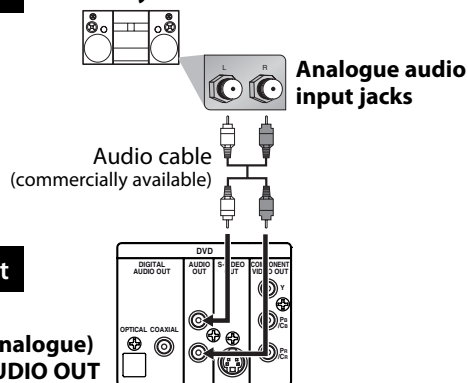

Connection	Setting	SETUP > Playback > Audio > Digital Out >		
		Dolby Digital	MPEG	DTS
Connecting to Stereo System.		PCM	PCM	OFF

* To complete these settings, refer to pages 81-83.

Digital Connection to Audio Equipment or MD deck without a Dolby Digital Decoder

- Audio CDs can be transferred digitally to other equipment such as an MD deck or DAT deck, play the disc as you would normally with the connection shown above, right. Audio CDs recorded in the DTS format cannot be transferred digitally or via analogue.
- Some Audio CDs have a short silent section between musical tracks. When sound from discs such as these is digitally recorded by connecting the unit directly to a digital recorder (such as an MD deck or DAT deck), the music may be recorded continuously and track numbers may be lost.
- DVDs recorded in Dolby Digital 5.1 channel surround sound, DTS or MPEG Audio cannot be connected digitally to external recording equipment such as an MD deck or DAT deck.

It may be possible to record "Dolby Digital" or "MPEG" Audio via a digital connection if the unit output is set to "PCM" (see pages 81-83 "Digital Out"). Analogue recording is possible but not for DTS recorded audio.

Note

- Playing back a DVD using incorrect settings may generate noise distortion and may also damage the speakers.
- AUDIO OUT jacks are not available on the DTS audio.

Playing Dolby Digital (5.1 channel audio), DTS or MPEG audio

Connecting an amplifier with a Dolby Digital/ DTS/ MPEG audio digital surround processor to your unit's audio digital jack provides richer and more powerful audio play. This connection is not possible if the processor or amplifier to which you want to connect does not have an audio digital input jack.

Dolby Digital decoder, DTS decoder, MPEG decoder, MD deck or DAT deck

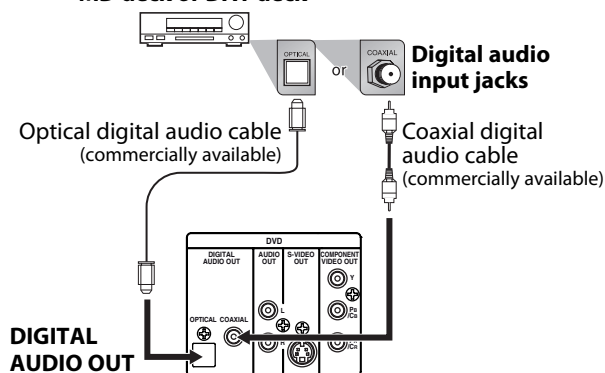

Connection	Setting	SETUP > Playback > Audio > Digital Out >		
		Dolby Digital	MPEG	DTS
Connecting to a Dolby Digital, DTS decoder or MPEG decoder for Dolby Digital, DTS or MPEG audio output.		Stream	Stream	ON
Connecting to the other equipment (an MD deck or DAT deck etc.) without Dolby Digital decoder.		PCM	PCM	OFF

* To complete these settings, refer to pages 81-83.

Optical cable (not supplied)

- Optical cable (not supplied) may be damaged when bent at sharp angles. Ensure cables are coiled in loops with a diameter of 15cm or more when storing them.
- Use a cable which is 3m or shorter.
- Insert cable plugs firmly into the connectors when making connections.
- If a plug has dust or is dirty, clean it with a soft cloth before inserting it into a connector.

Note

- The DVD AUDIO OUT and DIGITAL AUDIO OUT jacks are only useful in DVD mode.
- The audio source on a disc in a Dolby Digital 5.1 channel surround format cannot be recorded as digital sound by an MD or DAT deck.
- Playing back a DVD using incorrect settings may generate noise distortion and may also damage the speakers.
- By hooking this unit up to a Multi-channel Dolby Digital decoder, you can enjoy high-quality Dolby Digital 5.1 channel surround sound as heard in the movie theatres.
- By hooking this unit up to the DTS decoder, you can enjoy 5.1 channel surround system which reproduces the original sound as truthfully as possible. 5.1 channel surround system is developed by the Digital Theater Systems, Inc.

Getting started

Easy DVD recording

The following will help you to understand easily how to record on DVD discs. Make sure batteries are in the remote control and you have connected this unit and the TV correctly.

Step 1: Choose a disc type.

There are several types of recordable DVD discs to choose from. Choose a recordable DVD disc type based on your playback / recording / editing needs. See "DVD disc types" at the bottom of this page for more information on the differences among various compatible media.

This unit can record on the following type of discs.

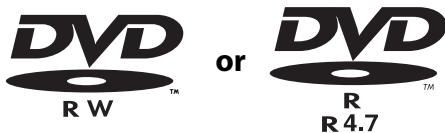

For example, when you want to record repeatedly on the same disc or when you want to edit the disc after recording, select the rewritable DVD-RW type disc.

When you want to save recordings without any alteration, a non-rewritable DVD-R can be your choice.

Step 2: Insert a blank disc.

Remote Control

- 1** Turn on the unit.
- 2** Select the DVD mode.
- 3** Open the disc tray.
- 4** Insert a recordable disc you wish to record.
- 5** Close the disc tray.

This operation may take a while to be recognised.

DVD disc types

☆☆☆ : Most suitable. ☆☆☆ : Can be used. ☆ : Some functions are limited. — : Cannot be used.

You want to	DVD-RW VR	DVD-RW Video	DVD-R Video
Record TV programmes	☆☆☆	☆☆☆	☆☆
Reuse by deleting unwanted contents	☆☆☆	☆☆	—
Edit the contents	☆☆☆	☆	☆
Edit/Record from connected equipment	☆☆☆	☆☆☆	☆☆☆
Copy discs for distribution	☆☆ ^{*1}	☆☆☆	☆☆☆
Playback on other DVD equipment	☆☆ ^{*1}	☆☆☆	☆☆☆

Features	DVD-RW VR	DVD-RW Video	DVD-R Video
Recording			
Rewritable	Yes	Yes	No
Can create chapters at fixed intervals (Automatically)	Yes	Yes	Yes
Can create chapters wherever you like (Manually)	Yes	No	No
Can record 16:9 size pictures	Yes	Yes	Yes
Can record Copy-Once programmes	Yes	No	No
Editing			
Can perform basic editing functions	Yes	Yes	Yes
Can perform advanced editing functions (Playlist edit)	Yes	No	No

^{*1} DVD-RW (VR mode) can only be played on DVD equipment that is VR compatible.

Note

For details of the above functions and implied restrictions, see the explanations inside this Operation Manual.

Format the disc

Insert the disc in the unit. Then, format the disc from the Setup menu. Video format (Video mode) or Video recording format (VR mode) will be available depending on the inserted disc type.

Formatting is only necessary to prepare the disc for recording. Details are on pages 26-28.

When you format a disc, the entire contents on that disc will be erased.

- The unit automatically starts formatting when an unused disc is inserted.

Getting started

Easy DVD recording (cont'd)

Step 3: Select the recording mode.

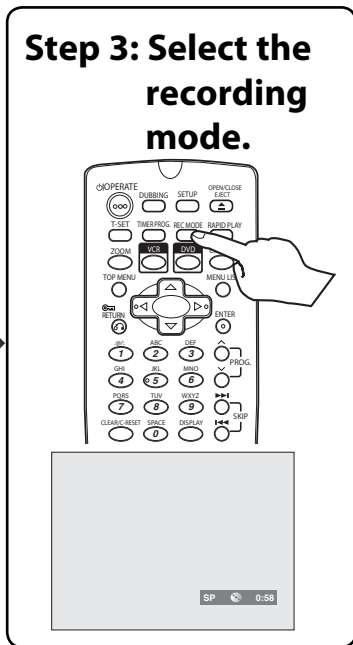

Step 4: Select the desired channel.

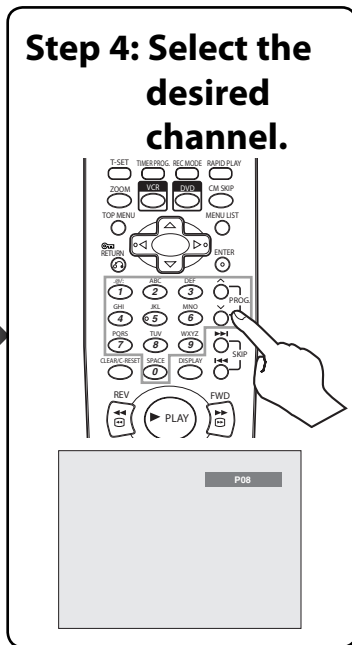

Step 5: Record to DVD discs.

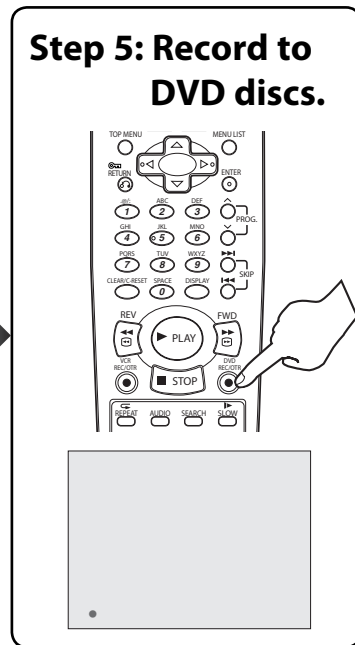

Hint 1: Play back the recorded contents

You can select the title you want to play back from a displayed menu and immediately start playback. Recorded contents are easily accessible, with simple procedure of choosing a title on a chapter on the menu screen.

What are titles and chapters?

The contents of a DVD disc are generally divided into titles. Titles may be further divided into chapters.

Hint 2: Edit the recorded disc

You will find editing discs is easy. This unit offers convenient editing functions which are possible only with DVD-RW/-R discs.

Title List offers the following editing functions.

- Putting names on titles
- Setting pictures for thumbnails
- Setting / clearing chapter marks
- Deleting parts of titles or scenes

(Possible editing functions depend on the recording format and editing method.)

Original and Playlist (VR mode)

You can edit the contents on a Playlist without changing the original recordings. A Playlist does not take up much disc space.

What "Original" or "Playlist" is for?

Throughout this Operation Manual, you will find *Original* and *Playlist* to refer to the original content and the edited version.

- **Original** content refers to what's originally recorded on the disc.
- **Playlist** content refers to the edited version of the original content.

Finalising a Disc

- You need to record in Video mode and finalise the disc to play it back on other players.
- Once you finalise a disc recorded in Video mode, you cannot record or edit any information on the disc.
- Discs recorded in VR mode can still be edited after finalisation.

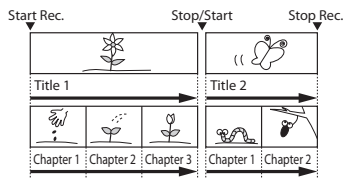

Step 6: Stop the record.

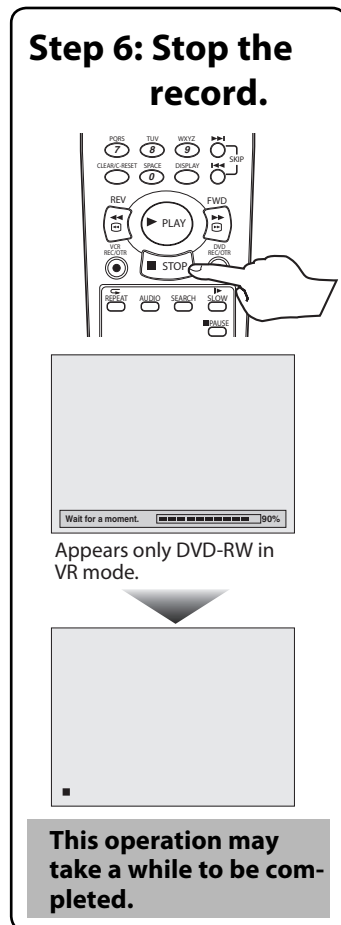

Getting started

Channel setting

Tuning of this unit to broadcast channels can be performed in two ways.

Auto Tuning

Programme the tuner to scan only the channels you can receive in your area.

1

In stop mode, press [SETUP].
Setup menu will appear.

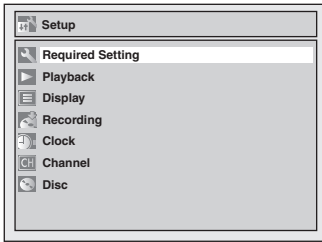

2

Select "Channel" using [Cursor ▲ / ▼], then press [ENTER].

3

Select "Auto Tuning" using [Cursor ▲ / ▼], then press [ENTER].

The unit will start storing channels available in your area.

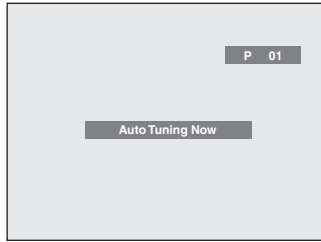

Wait for about 10 minutes to finish channel storing.

4

Press [SETUP] to exit.
You can select only the channels memorised in this unit by using [PROG. ▲ / ▼].

To select a channel

You can select a channel using [PROG. ▲ / ▼], or directly enter the channel using [the Number buttons] on the remote control.

To cancel auto tuning

Press [RETURN] or [SETUP] during scanning.

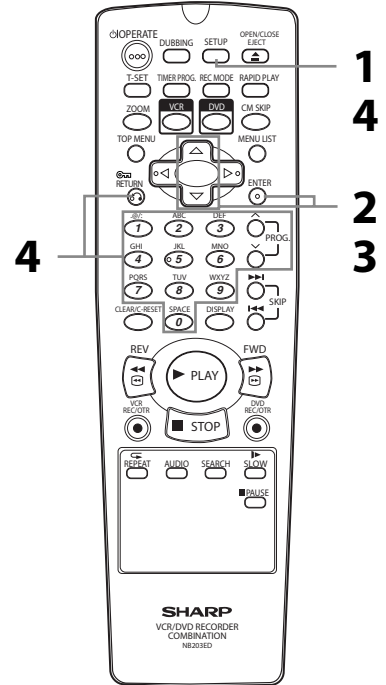

Note

- The selection will be affected by how you receive TV channels in your local area.
- If the auto tuning is cancelled during scanning, some channels not yet tuned may not be received.
- You cannot change the channel when either VCR or DVD is in any recording mode (normal recording, One-touch Timer Recording or timer recording).

Getting started

Channel setting (cont'd)

Manual Tuning

Manually tune each channel.

1

In stop mode, press [SETUP].

2

Select "Channel" using [Cursor ▲ / ▼], then press [ENTER].

3

Select "Manual Tuning" using [Cursor ▲ / ▼], then press [ENTER].

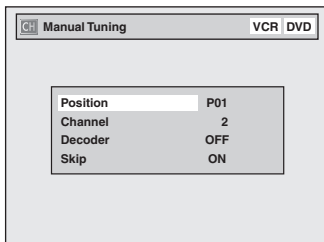

4

Select "Position" using [Cursor ▲ / ▼], then press [Cursor ►]. "P01" is highlighted.

5

Select the position number you wish to use using [the Number buttons] or [Cursor ▲ / ▼], then press [Cursor ◀].

You can select position numbers 01 to 99.

6

Select "Channel" using [Cursor ▲ / ▼], then press [Cursor ►].

7

Press [Cursor ▲ / ▼] to start scanning.

- The tuner will begin to search up or down automatically. When a channel is found, the unit will stop searching and the picture will appear on the TV screen.

- You can select a desired channel number using [the Number buttons]. Refer to the following Channel Plan table and press the three digits to select the channel number. (To select channel 4, press [0] first and then press [0] and [4]. Or press [4] and then "--4" appears and wait for 2 seconds.)
- If this is the channel you want, press [Cursor ◀].

Channel Plan in Australia	
CH. Indication	TV Channel
00 - 13	0 - 13
28 - 69	28 - 69
84	9A
85	5A

Channel Plan in New Zealand	
CH. Indication	TV Channel
00 - 02	1 - 3
06 - 09	4 - 7
10 - 12	9 - 11
21 - 74	21 - 69
84	8

This unit can receive the Hyper and Oscar frequency bands.

- If "Skip" is set to "ON," select "Skip" using [Cursor ▲ / ▼], then press [Cursor ►]. Select "OFF" using [Cursor ▲ / ▼], then press [Cursor ◀].
- If you want to decode scrambled signals, select "Decoder" using [Cursor ▲ / ▼], then press [Cursor ►]. Select "ON" using [Cursor ▲ / ▼], then press [Cursor ◀].
- To store another channel, repeat steps 4 to 7.

8

After completion, press [SETUP] to exit.

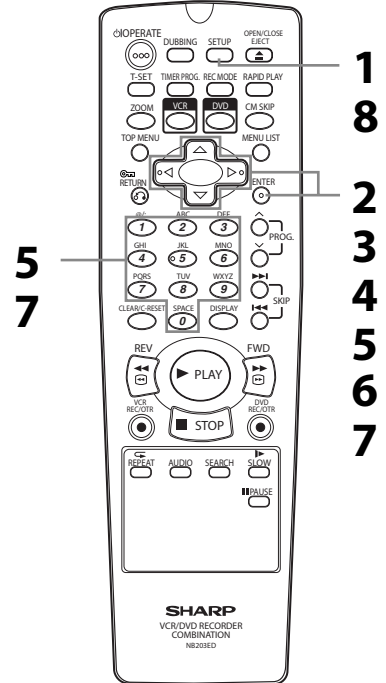

Getting started

Channel setting (cont'd)

To select a channel

Notes on using [the Number buttons]:

- Enter channel numbers as a two-digit number for the quickest result. For example, to select channel 6, press [0] and [6]. If you only press [6], channel 6 will be selected after 2 seconds. You can only select channels 1 to 99.
- You can select the external input mode "AV1", "AV2", or "AV3".
 - To select the "AV1", "AV2", or "AV3", press [0], [0], [1] or [0], [0], [2] or [0], [0], [3] accordingly or use [PROG. ^ / v].
- To select the external input mode "AV4" for DV connection, you must use [PROG. ^ / v].

To skip a Preset channel

You can set the unit to skip channels you can no longer receive or seldom watch when you access channels using [PROG. ^ / v].

- 1** Follow the steps 1 to 3 in "Manual Tuning" on page 20.
- 2** Select "Position" using [Cursor ▲ / ▼], then press [Cursor ►].
- 3** Select the position number you wish to skip using [the Number buttons] or [Cursor ▲ / ▼], then press [Cursor ◀].

Move

You can replace two channels.

- 1** In stop mode, press [SETUP].
- 2** Select "Channel" using [Cursor ▲ / ▼], then press [ENTER].
- 3** Select "Move" using [Cursor ▲ / ▼], then press [ENTER].
- 4** Select the position number of which you want to change the channel using [Cursor ▲ / ▼], then press [ENTER].

- 4** Select "Skip" using [Cursor ▲ / ▼], then press [Cursor ►].
- 5** Select "ON" using [Cursor ▲ / ▼], then press [Cursor ◀].
 - To skip another channel, repeat steps 2 to 5.
- 6** Press [SETUP] to exit.

You cannot select a position number where "--" appears next to the number, because "Skip" is set to "ON" for that position number.

- 5** Move the channel to another position number using [Cursor ▲ / ▼], then press [ENTER].
 - To move another channel, repeat steps 3 to 5.
- 6** Press [SETUP] to exit.

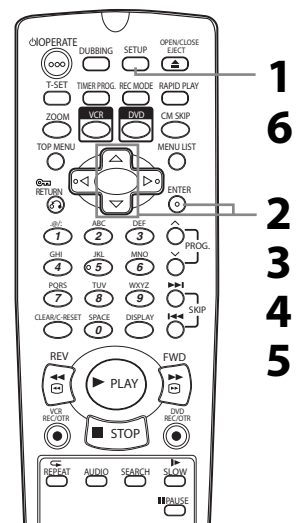
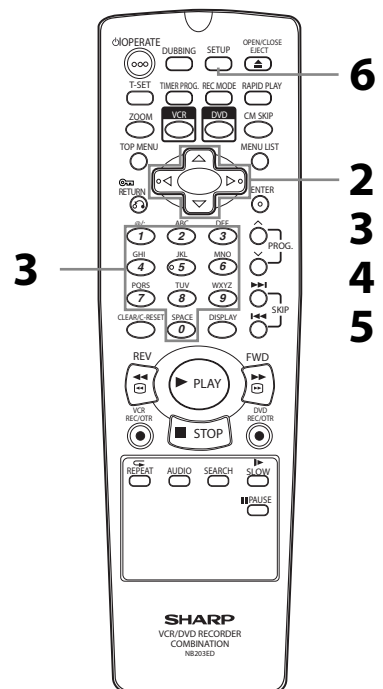

Getting started

Setting the clock

Clock Setting

1
In stop mode, press [SETUP].

2
Select "Clock" using [Cursor ▲ / ▼], then press [ENTER].

3
Select "Clock Setting" using [Cursor ▲ / ▼], then press [ENTER].

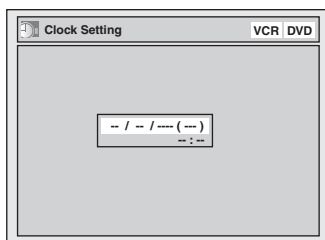

4
Press [ENTER] again.
Default date will appear.

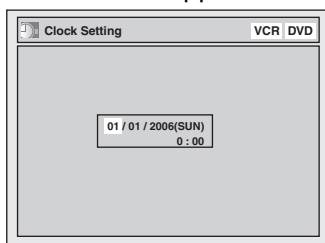

5
Enter the date (day / month / year) using [Cursor ▲ / ▼].
Press [Cursor ►] to move the cursor to the next field. If you wish to go back to the previous field, press [Cursor ◀].

6
Enter the time (hour / minute) using [Cursor ▲ / ▼], then press [ENTER].

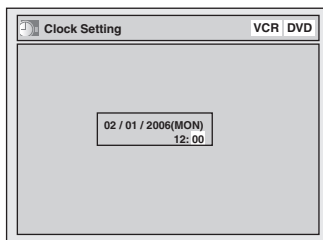

The clock will start.
• Although seconds are not displayed, they will be counted from zero.

7
Press [SETUP] to exit.

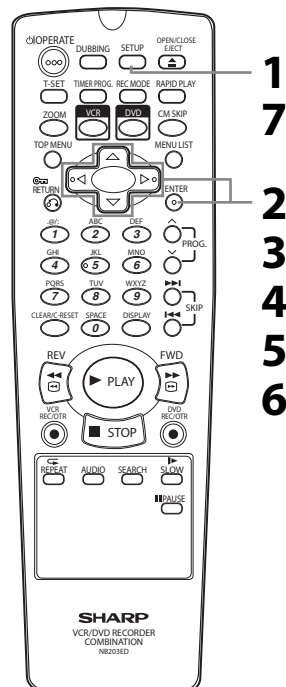

Note

- Your clock setting will be lost if either there is a power failure or the unit is unplugged for more than 1 hour.

Getting started

Selecting the On-Screen Display (OSD) language

1
In stop mode, press [SETUP].

2
Select "Display" using [Cursor ▲ / ▼], then press [ENTER].

3
Select "OSD Language" using [Cursor ▲ / ▼], then press [ENTER].

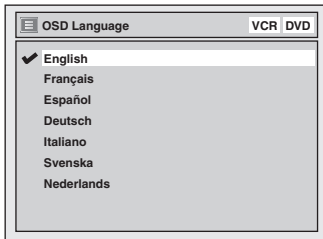

4
Select the appropriate OSD language using [Cursor ▲ / ▼], then press [ENTER].

5
Press [SETUP] to exit.

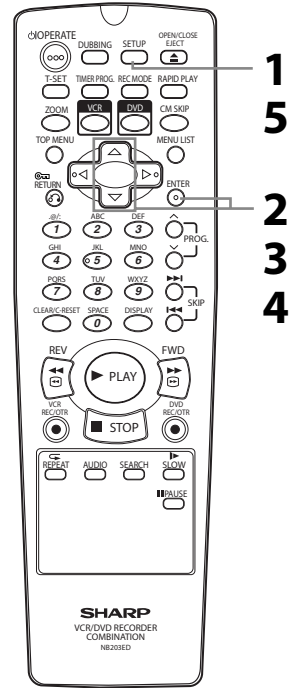

Before you start

Connections

Getting started

Recording

Disc Playback

Editing

Changing the Setup menu

VCR functions

Others

Selecting the TV aspect ratio

You can select the TV aspect ratio to match the format of the programme you are playing back with the unit and that of your TV screen (4:3 standard or 16:9 wide screen TV).

1
In stop mode, press [SETUP].

2
Select "Required Setting" using [Cursor ▲ / ▼], then press [ENTER].
Required Setting menu will appear.

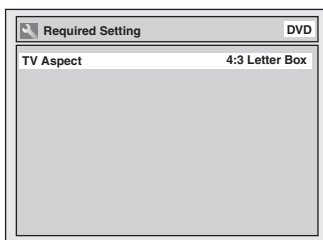

3
Select "TV Aspect" using [Cursor ▲ / ▼], then press [ENTER].

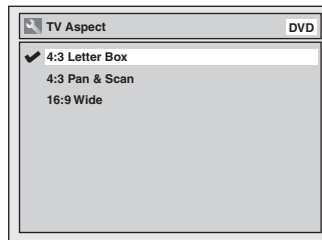

4
Select the desired option using [Cursor ▲ / ▼], then press [ENTER].

5
Press [SETUP] to exit.

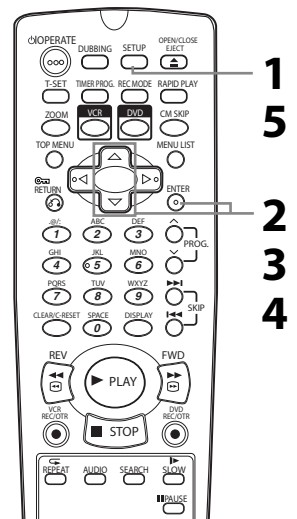

Note

If you have a standard TV:

- Select "4:3 Letter Box" for a full width picture with black bars at the top and bottom.
- Select "4:3 Pan & Scan" for a full height picture with both sides trimmed.

If you have a wide screen TV:



- Select "16:9 Wide".

Recording

Information on DVD recording

Type of discs

This unit can record on DVD-RW and DVD-R. You can record on DVD-R only once. On DVD-RW, you can record and erase many times. It is possible to record on DVD-R only in Video mode. DVD-RW can record in the format you select from Video mode or VR mode.

Logo	Attributes
	8cm / 12cm, single-sided, single layer disc
DVD-RW	Max. recording time (10H mode, approx.):
	600 minutes (4.7GB) (for 12cm)
	180 minutes (1.4GB) (for 8cm)
DVD-R	

If you want to record repeatedly on the same disc, or if you want to edit the disc after recording, use a rewritable DVD-RW type disc.

If you want to save recordings without any alteration, use a non-rewritable DVD-R type disc.

Recordable discs





- Discs that should or should not be used with this recorder:
DVD-R 8x can be used.
DVD-RW 4x can be used, 6x may result in a Rec error.
- We strongly recommend for good recording quality:
Verbatim DVD-R 8x
Verbatim DVD-RW 2x

Video mode and VR (Video Recording) mode

Video mode is the same recording format as used on the pre-recorded DVD-Videos you purchase in local shops, so you can play back the discs recorded in this format in most DVD players. You will need to finalise such discs (see pages 40-41) before playing them back in other DVD players. Unless finalised, you can record additional materials or edit discs recorded in Video mode with this unit.

VR (Video Recording) mode is a basic recording format for DVD-RW discs. You can record and edit material repeatedly. It is impossible to record additional materials on a disc formatted in VR mode and already recorded in another video system other than PAL, such as NTSC.

DVD players bearing the  logo are capable of playing back DVD-RW discs recorded in VR mode.

Disc type	Disc format	Functions
	Video mode 	Playing back, Limited recording, Limited editing
DVD-RW	VR mode 	Playing back, Recording, Original / Playlist editing
	Video mode 	Playing back, Limited recording, Limited editing
DVD-R		

Recording mode

You can select a recording mode from 6 options. The recording time will vary depending on the recording mode you select as follows.

Discs recorded in SLP or SEP on this unit may not be played back on other DVD recorders or DVD players.

Recording mode	Recording time		Video/ Sound Quality
	12cm	8cm	
XP	60 min	18 min	☆☆☆☆☆☆
SP	120 min	36 min	☆☆☆☆☆
LP	240 min	72 min	☆☆☆☆
EP	360 min	108 min	☆☆☆
SLP	480 min	144 min	☆☆
SEP	600 min	180 min	☆

- This table is intended for a standard new single sided 12cm / 8cm disc. The recording times are estimates and actual recording time may differ.
- The audio and video quality becomes poorer as the recording time gets longer.

Restrictions on recording

You cannot record copy-protected video using this unit. Copy-protected video includes DVD-Videos and some satellite broadcasts.

If copy-protected material is detected, recording will pause or stop automatically and an error message appears on the screen.

You can only record "Copy-once only" video using a DVD-RW disc in VR mode with Content Protection for Recordable Media (CPRM).

When recording a TV broadcast or an external input, you can display copy control information on the screen.



CPRM is a scrambling copy protection system for the protection of "copy-once" broadcast programmes. This unit is CPRM compatible, which means that you can record copy-once broadcast programmes, but you cannot then make a copy of those recordings. CPRM recordings can only be played back on DVD players that are specifically compatible with CPRM.

Recording

Information on DVD recording (cont'd)

Information on copy control

Some satellite broadcasts include copy-protected information. If you wish to record them, refer to the following.

Disc type / format	Copy-free	Copy-once	Copy-prohibited
ver.1.1, 1.2	☆	—	—
 ver.1.1/ x2 CPRM compatible	☆	☆	—
ver.1.2/ x4 CPRM compatible			
ver.1.1, 1.2			
 ver.1.1/ x2 CPRM compatible	☆	—	—
ver.1.2/ x4 CPRM compatible			
ver.2.0			
 ver.2.0/ x4	☆	—	—
ver.2.0/ x8			

☆ Recordable
— Not Recordable

Note

- This unit cannot record on CD-RW or CD-R discs.
- DVD-RW/-R and CD-RW/-R discs recorded on a personal computer or a DVD or CD recorder may not be played back if the disc is damaged or dirty or if there is condensation on the player's lens.
- If you record a disc using a personal computer, even if it is recorded in a compatible format, it may not be played back because of the settings of the application software used to create the disc. (Check with the software publisher for more detailed information.)
- Discs recorded in Video mode on this unit cannot record additional information using other DVD recorders.
- It is not possible to use a DVD-RW disc formatted with this unit on other DVD recorder unless the content of the disc was also recorded with this unit.
- Since recording is performed using the Variable Bit Rate (VBR) method, the actual remaining time for recording may be a little shorter than the remaining time displayed on the OSD, depending on the picture you are recording.

Making discs playable in other DVD players (Finalise)

After recording, you must finalise the disc to play it back in other players. (See page 40.)
You cannot finalise discs in other DVD recorders.

After finalising

- After DVD-R discs are finalised:
 - A Title menu is created automatically.
 - Undo finalising is not possible.
 - Additional recording or editing is not possible.
- After DVD-RW (Video mode) discs are finalised:
 - A Title menu is created automatically.
 - Undo finalising is possible. (See page 41.)
 - Additional recording or editing is possible if you undo finalise. (See page 41.)
- After DVD-RW (VR mode) discs are finalised:
 - A Title menu is not created.
 - Undo finalising is possible. (See page 41.)
 - Additional recording or editing is possible even without undo finalising.

Usable discs

☆☆☆ : Most suitable, ☆☆ : Can be used,
☆ : Some functions are limited, — : Cannot be used.

Applications	DVD-RW		DVD-R
	VR	VIDEO	
Record TV programmes	☆☆☆	☆☆☆	☆☆
Reuse by deleting the current contents	☆☆☆	☆☆	—
Edit the contents	☆☆☆	☆	☆
Edit / Record from external equipment	☆☆☆	☆☆☆	☆☆☆
Copy discs for distribution	☆☆ *	☆☆☆	☆☆☆
Playback on other DVD equipment	☆☆ *	☆☆☆	☆☆☆

Features

	Yes	Yes	No
Rewritable	Yes	Yes	No
Can create chapters at fixed intervals (Automatically)	Yes	Yes	Yes
Can create chapters wherever you like (Manually)	Yes	No	No
Can record 16:9 size pictures	Yes	Yes	Yes
Can record Copy-Once programmes	Yes	No	No
Can perform basic editing functions	Yes	Yes	Yes
Can perform advanced editing functions (Playlist edit)	Yes	No	No

* You can only play back DVD-RW disc recorded in VR mode on VR-compatible discs.

Note

- For details of the above functions and restrictions, see the further explanations in this Operation Manual.

Recording

Formatting a disc

Choosing the recording format of a brand-new DVD-RW disc



When inserting a brand-new disc, the unit automatically starts to initialise the disc. You can also manually format a DVD-RW disc once it has been used.

1
In stop mode, press [SETUP].

2
Select "Disc" using [Cursor ▲ / ▼], then press [ENTER].
Disc menu will appear.

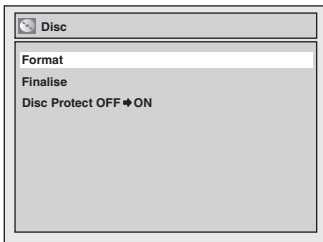

3
Select "Format" using [Cursor ▲ / ▼], then press [ENTER].
Format menu will appear.

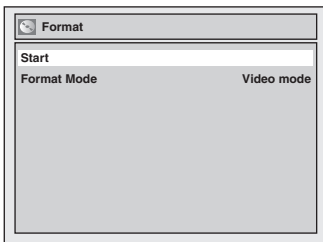

4
Select "Format Mode" using [Cursor ▲ / ▼], then press [ENTER].

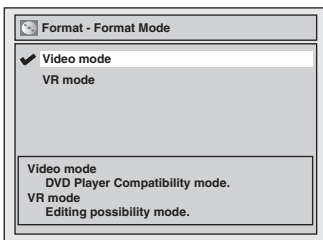

5
Select "Video mode" or "VR mode" using [Cursor ▲ / ▼], then press [ENTER].

6
Press [SETUP] to exit.

7
Insert a brand-new disc.
Formatting will start.

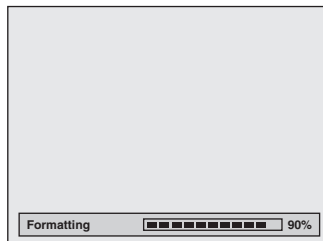

8
Formatting is completed.
"100%" is indicated.

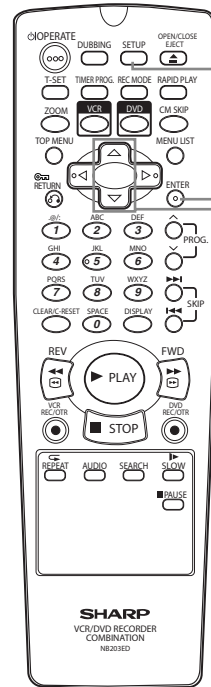

Note

- The recording format setting is effective only for DVD-RW discs. You cannot change the recording format for a DVD-R disc. DVD-R discs are always in Video mode.
- You cannot mix two formats on one DVD-RW disc. If you insert a disc that has been recorded before, the recording format cannot be changed even if you change it in the Setup menu.
- The unit is not compatible with DVD+RW/+R discs. If a brand-new DVD+RW or DVD+R disc is inserted, the error message ("Disc Error") will appear.

Recording

Formatting a disc (cont'd)

Setting Auto Chapter



The unit inserts a chapter mark periodically (every 10 minutes by default) during recording. Using the Auto Chapter menu, you can set this function off or change the time period.

1
In stop mode, press [SETUP].

2
Select "Recording" using [Cursor ▲ / ▼], then press [ENTER].

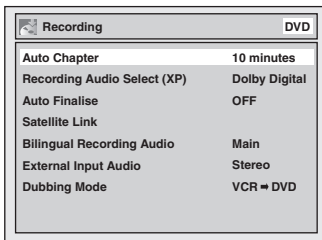

3
Select "Auto Chapter" using [Cursor ▲ / ▼], then press [ENTER].

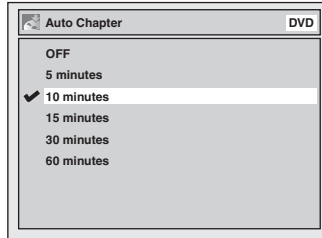

4
If you wish to set "Auto Chapter" off, select "OFF" using [Cursor ▲ / ▼], then press [ENTER].

If you wish to change the time period for Auto Chapter, select the required time period using [Cursor ▲ / ▼], then press [ENTER].

5
Press [SETUP] to exit.

Recording Audio Select (XP)



You can enjoy high quality sound recording. This function works only when the recording mode is set at XP.

1
In stop mode, press [SETUP].

2
Select "Recording" using [Cursor ▲ / ▼], then press [ENTER].

3
Select "Recording Audio Select (XP)" using [Cursor ▲ / ▼], then press [ENTER].

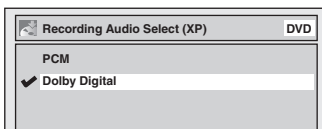

The default is "Dolby Digital".

4
Select "PCM" or "Dolby Digital" using [Cursor ▲ / ▼], then press [ENTER].

PCM:
Records PCM audio for the best quality sound.

Dolby Digital:
Records Dolby Digital audio for good quality sound.

5
Press [SETUP] to exit.

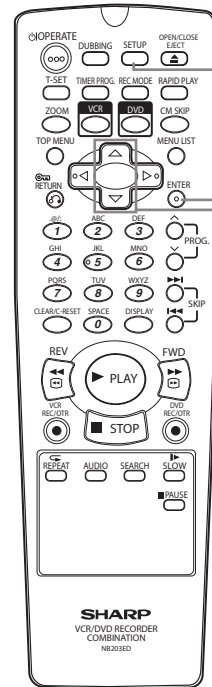

Note
• You cannot set or clear chapter marks on DVD-R discs manually.

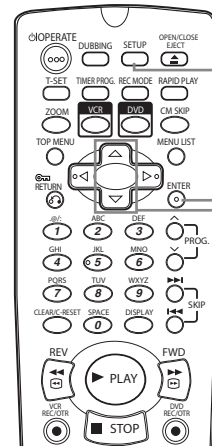

Note
• "PCM" stands for Pulse Code Modulation. It changes analogue sound to digital sound without compressing audio data.
• When the recording mode is set at other than XP, the unit records "Dolby Digital" audio automatically even if you selected "PCM".

Before you start

Connections

Getting started

Recording

Disc Playback

Editing

Changing the Setup menu

VCR functions

Others

Recording

Formatting a disc (cont'd)

Reformatting a disc manually



If you are using a DVD-RW disc, you can format the disc by performing "Format". By default it will be in Video mode. You can change this to VR mode using the Setup menu.

Note

- When you reformat the disc, the contents of the disc are erased.
- Make sure that the recording format is set to the desired mode. (See steps 1 to 6 in "Choosing the recording format of a brand-new DVD-RW disc" on page 26.)

Insert a recordable disc.

1

In stop mode, press [SETUP].

2

Select "Disc" using [Cursor ▲ / ▼], then press [ENTER].

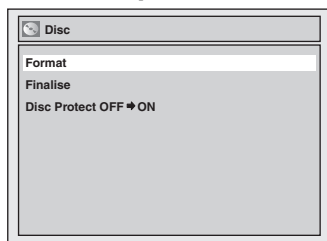

3

Select "Format" using [Cursor ▲ / ▼], then press [ENTER].

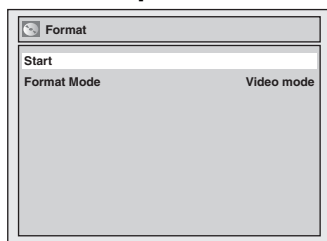

4

Select "Start" using [Cursor ▲ / ▼], then press [ENTER].

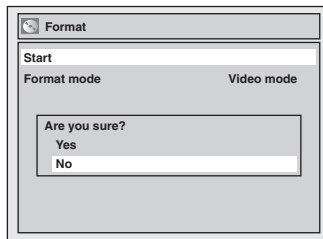

A popup window will appear and prompt you to confirm.

5

Select "Yes" using [Cursor ▲ / ▼], then press [ENTER].

Formatting will start.

If you want to cancel formatting, select "No".

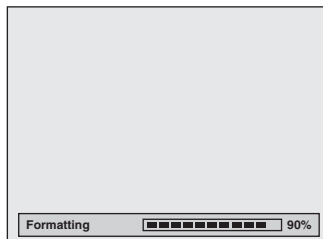

6

Formatting is completed.

"100%" is indicated.

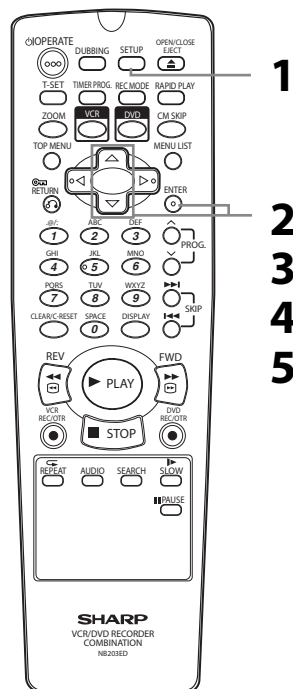
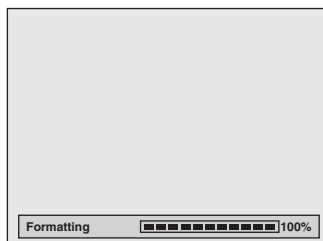

Note

- It is not possible to use a disc formatted with this unit on other DVD recorder. When you use a disc with another DVD recorder, format a disc using that DVD recorder.

Recording

Selecting the Sound mode

This unit can receive bilingual broadcasts.

You can switch between modes by pressing [AUDIO] on the remote control. Each mode is indicated on the TV screen as follows.

- During reception of bilingual broadcasts

Mode	Audio output	Display on the TV screen
Main	Main audio from both speakers	Main
Sub	Sub audio from both speakers	Sub
Main / Sub	• Main audio from the left speaker • Sub audio from the right speaker	Main / Sub

Setting External Input Audio

When the external input audio is a bilingual broadcast, you can choose "Stereo" or "Bilingual" to record on a DVD.

1
In stop mode, press [SETUP].

2
Select "Recording" using [Cursor ▲ / ▼], then press [ENTER].

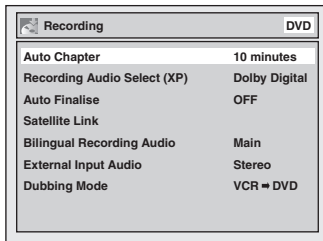

3
Select "External Input Audio" using [Cursor ▲ / ▼], then press [ENTER].

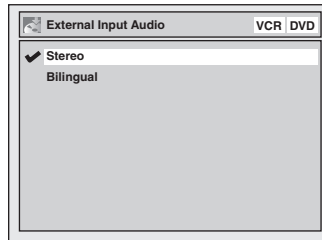

4
Select "Stereo" or "Bilingual" using [Cursor ▲ / ▼], then press [ENTER].

5
Press [SETUP] to exit.

Setting Bilingual Recording Audio

You can select either "Main" or "Sub" audio to record a bilingual broadcast in Video mode.

1
In stop mode, press [SETUP].

2
Select "Recording" using [Cursor ▲ / ▼], then press [ENTER].

3
Select "Bilingual Recording Audio" using [Cursor ▲ / ▼], then press [ENTER].

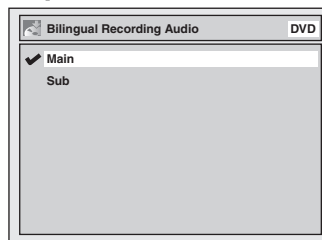

4
Select "Main" or "Sub" using [Cursor ▲ / ▼], then press [ENTER].

5
Press [SETUP] to exit.

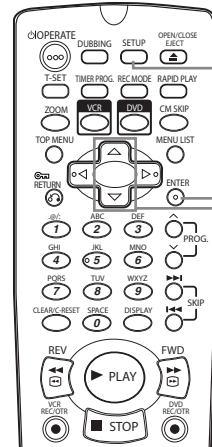

Note

- If you select "Stereo":
The audio will be recorded as "stereo audio".
- If you select "Bilingual":
The audio will be recorded as "bilingual audio" (see next section for more detail).

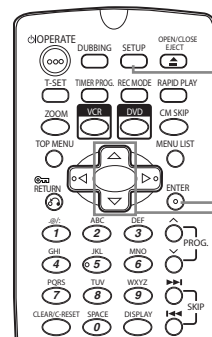

Note

- If you are recording onto a VR mode disc, both "Main" and "Sub" will be recorded regardless of your setting here. And when you play back, you can choose either audio format or a combination of both as your playback audio.

Recording

Basic recording / One-touch Timer Recording (OTR)



Follow the steps below to record a TV programme.



1 Press [OPERATE] to turn on the unit.

Turn on the TV and be sure to select the input to which the unit is connected.

2 Press [OPEN/CLOSE EJECT ▲] to open the disc tray.

3 Place the disc on the disc tray with its label facing up. Be sure to align the disc with the disc tray guide.

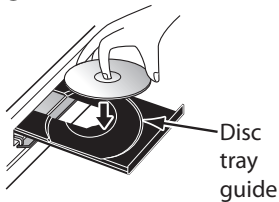

4 Press [OPEN/CLOSE EJECT ▲] to close the disc tray.

5 Select the recording mode using [REC MODE]. (See page 24.)

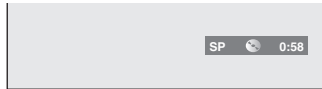

6 Select the desired channel to record using [PROG. ^ / v] or [the Number buttons].

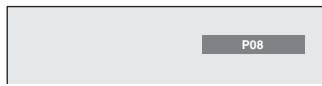

7 Press [DVD REC/OTR ●] to start recording. The "●" mark will be displayed for 5 seconds.

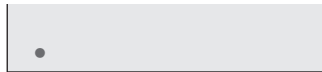

To pause the recording, press [PAUSE ■]. Press [PAUSE ■] or [DVD REC/OTR ●] again to restart the recording.

8 Press [STOP ■] to stop the recording.

This operation may take a few moments to complete.

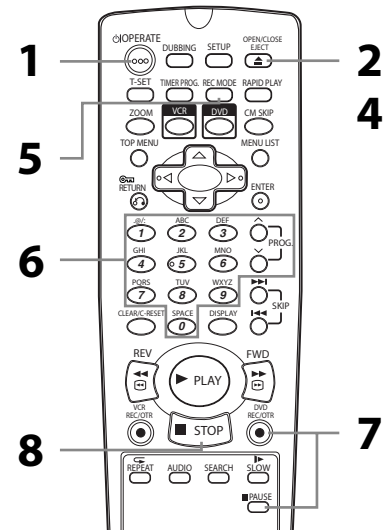

To set the One-touch Timer Recording (OTR)

This is a simple way to set the recording time in blocks of 30 minutes.

At step 7, press [DVD REC/OTR ●] repeatedly until the desired recording time (30 minutes to 8 hours) appears on the TV screen.

One-touch Timer Recording will start.

- To change the recording length during one-touch timer recording, press [DVD REC/OTR ●] repeatedly until the desired length appears.
- To cancel One-touch Timer Recording within the specified time, press [STOP ■].
- The remaining recording time will be displayed on the front panel display during One-touch Timer Recording. Press [DISPLAY] to see it on the TV screen.
- Unlike the timer recording, you can perform the following operations during One-touch Timer Recording.
 - Turning off the power.
 - Using [DVD REC/OTR ●] or [STOP ■].
- You cannot use the pause function during One-touch Timer Recording.**
- If DVD One-touch Timer Recording is completed during VCR playback or recording, the DVD will be in stop mode and the VCR keeps the current mode.
- When One-touch Timer Recording is finished and the power is turned off, the unit will switch to the timer-standby mode automatically if a timer recording has been programmed. Press [T-SET] to cancel the timer-standby mode to use the unit continuously.

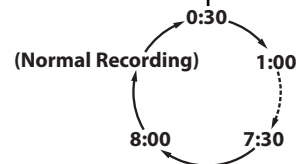

Note

- You can change the channel while in the REC pause mode when basic recording.
- You cannot change the recording mode while in the REC or REC pause mode.
- If the clock is not set, the date and time space next to title names in the Original or Playlist will be blank.
- The unit will be turned off automatically under the following conditions.
 - No space remains on the disc.
 - If a power failure occurs.
- If you want to monitor the programme that you are recording, make sure the device such as Set-top Box is turned off when it is connected to AV2.
- Even if the broadcasting you are recording is in the SECAM system, this unit automatically converts it to the PAL system when recording.

Recording

Timer Recording



You can set the unit to record up to 8 programmes, up to a month in advance. Daily or weekly programme recordings are also available.

- Be sure to set the clock before entering a timer programming.

Insert a recordable disc or a tape with a record tab.

1
In stop mode, press [TIMER PROG.].

Timer Programming list will appear.

Timer Programming						VCR	DVD
Date	Start	End	CH	DVD VCR	Mode		
1. 01/01	12:00	--:--	P01				
2. ---							

2
Select a programme that is not set using [Cursor ▲ / ▼], then press [ENTER].

3
Enter the date using [Cursor ▲ / ▼], then press [Cursor ►].

Timer Programming						VCR	DVD
Date	Start	End	CH	DVD VCR	Mode		
1. 01/01	12:00	--:--	P01				
2. ---							

Each time you press [Cursor ▼] at the current date, the timer recording date will change as follows.

e.g., 1st January

01/01	↓
Daily	↓
M-F (Mon.-Fri.)	↓
W-SAT	↓
W-FRI	↓
...	↓
W-SUN	↓
31/01	

4
Enter the time to start and to end using [Cursor ▲ / ▼], then press [Cursor ►].

Timer Programming						VCR	DVD
Date	Start	End	CH	DVD VCR	Mode		
1. 01/01	12:00	--:--	P01				
2. ---							

5
Select the channel number to record using [Cursor ▲ / ▼], then press [Cursor ►].

Timer Programming						VCR	DVD
Date	Start	End	CH	DVD VCR	Mode		
1. 01/01	12:00	13:00	P01				
2. ---							

To record from the external input, select "AV1", "AV2", or "AV3".

6
Select the recording media ("DVD" or "VCR") using [Cursor ▲ / ▼], then press [Cursor ►].

Timer Programming						VCR	DVD
Date	Start	End	CH	DVD VCR	Mode		
1. 01/01	12:00	13:00	P01		DVD		
2. ---							

7
Select the recording mode using [Cursor ▲ / ▼]. (See page 24.)

Timer Programming						VCR	DVD
Date	Start	End	CH	DVD VCR	Mode		
1. 01/01	12:00	13:00	P01		DVD	XP	
2. ---							

8
Press [ENTER] when all information required is entered. Your programme setting is stored.

- To set another programme, repeat steps 2 to 8.
- To exit, press [TIMER PROG.].
- If the recording times of two or more programmes overlap, "Overlap" and overlapped programme numbers are displayed. (See pages 32-33.)

9
Press [T-SET].

The  icon will appear on the front panel display and the unit enters to the timer-standby mode.

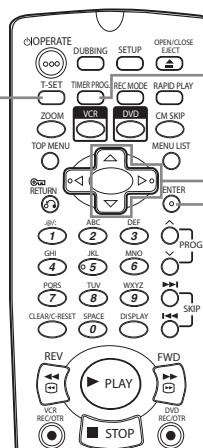

Note

- If you have not set the clock, the clock setting window will appear instead of the Timer Programming list. Continue from step 4 in "Clock Setting" on page 22 before programming the timer.
- Press [Cursor ◀ / ▶] to move the cursor in the Timer Programming list.
- If a basic recording or One-touch Timer Recording is in progress on one component (e.g. VCR) and the timer recording set for the other component (e.g. DVD) is about to begin, the unit automatically switches to the programmed channel for timer recording 2 minutes before the programmed starting time, and the recording in progress (for VCR) will be cancelled UNLESS their recording channels are the same. If their recording channels are the same, the timer recording will start without cancelling the recording currently in progress. In this case, the recording of the same channel will be made on both DVD and VCR.
- Cancel the timer-standby mode by pressing [T-SET] before operation for either DVD or VCR. When finished operating, press [T-SET] to resume the timer-standby mode.
- In the timer-standby mode, you can turn on the power and use the component (VCR or DVD) which is not currently timer-programmed.

Recording

Timer Recording (cont'd)

Checking, cancelling, or correcting the timer programming information

In the following example, No. 5 timer programming overlaps on No. 1 and No. 6 timer programmes. In such a case, you should correct the programme time to clear the overlap.

Timer Programming						VCR	DVD
Date	Start	End	CH	DVD VCR	Mode		
1. 01/01	12:00	13:00	P01	DVD	XP		
2. ---							
3. ---							
4. ---							
5. 01/01	12:30	14:00	P02	DVD	SP		
6. 01/01	13:45	21:00	P12	DVD	SEP		
7. ---							
8. ---							

1 Press [T-SET] so that the  icon disappears from the front panel display.

2 Press [TIMER PROG.].
Timer Programming list will appear.

Timer Programming						VCR	DVD
Date	Start	End	CH	DVD VCR	Mode		
1. 01/01	12:00	13:00	P01	DVD	XP		
2. ---							
3. ---							
4. ---							
5. ---							
6. ---							
7. ---							
8. ---							

To stop the timer recording in progress

Press [STOP ■] to stop the disc recording or [STOP ■/EJECT ▲] to stop the tape recording on the front panel of the unit.

If the timer programming did not complete correctly

The error number appears on the Timer Programming list.

Timer Programming						VCR	DVD
Date	Start	End	CH	DVD VCR	Mode		
* 01/01	12:00	13:00	P01	DVD	E1		
2. ---							
3. ---							

The error programme will be displayed in grey with an asterisk and have an error number.

The error programme will be deleted once you check the error in the programme list, or once you cancel the timer-standby mode and re-enter it.

Press [CLEAR/C-RESET] to erase the selected programme.

3 Check the information on the list you will need.

4 To clear the timer programming, select the desired programme using [Cursor ▲ / ▼], then press [CLEAR/C-RESET].

To correct the timer programming

- 1) Select the desired programme using [Cursor ▲ / ▼], then press [ENTER].
- 2) Correct the timer programming using [Cursor ▲ / ▼ / ◀ / ▶].
- 3) Press [ENTER] again.

5 Press [TIMER PROG.] to exit.

6 Press [T-SET] to return to the timer-standby mode.

To check the timer programming in progress
Press [TIMER PROG.].

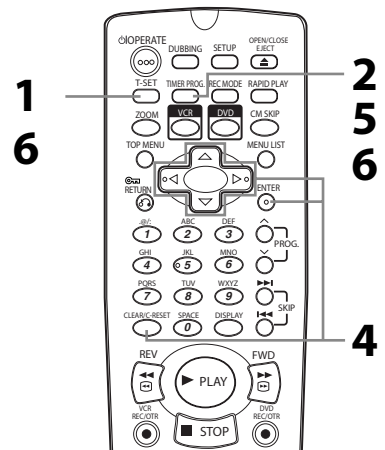

Note

- If a timer recording is proceeding, that programme is highlighted in red. In such a case, you cannot select any other programmes.
- When you check the timer programming in progress by pressing [TIMER PROG.] during operations of the component (VCR or DVD) which is not currently used for the timer recording, the programme will not be highlighted. In this case, you cannot select other programmings.

Note

- [STOP ■] on the remote control is not effective.



The error numbers indicate:

E1-22	Recording error	E34	No space for Control information
E37-39		E35	PCA (Power Calibration Area) full
E23-24	Unrecordable disc	E36	Already finalised Video format disc
E25	• Copy prohibited programme • Cannot record because of the NTSC / PAL-60 signal is received.	E40	• There are some unrecorded parts due to the overlapped timer programmes. • Recording did not start at the start time. • There is no tape in the cassette compartment. • Tape recording reaches to the tape end during timer recording.
E26-28	Copy prohibited programme		
E29	Disc protected		
E30	Disc full		
E31	Already recorded 99 titles (Video mode)		
E32	Already recorded 99 titles (VR mode)	E41	Power failure
E33	Already recorded 999 chapters	E42	No disc

Recording

Timer Recording (cont'd)

Hints for Timer Recording

- If there is a power failure or the unit is unplugged for more than 1 hour, the clock setting and all timer settings will be lost.
- If there is no disc or an unrecordable disc in the tray, the  icon will flash and the timer recording will not occur. Insert a recordable disc.
- If there is no tape or a tape with a record tab is not in the cassette compartment, the VCR indicator on the front panel flashes and the timer recording cannot be performed. Please insert a recordable tape.
- When all timer recordings are complete, the  icon flashes. To play back or eject the recorded disc, press [T-SET], and then press [PLAY ►] or [OPEN/CLOSE EJECT ▲].
- The timer recording cannot be performed in DVD and VCR at the same time. If you set two programmings with the same channel and time both in DVD and VCR, the programming that has priority will be recorded.
- You cannot make any DVD operation during DVD timer recording.
- You cannot make any VCR operation during VCR timer recording.
- If the Start and End times are same, the length of the recording will be set for 24 hours. If the disc or tape becomes full during recording, the unit will turn itself off. To continue recording, press [T-SET] to cancel the timer-standby mode, insert a recordable disc or tape and press [T-SET] again.
- If two or more programmes overlap, "Overlap" and the overlapped programme number will appear on the display.
- If the Start time is earlier and the End time is later than the current time, the recording will start immediately after you press [T-SET].
- If a videotape ends during the timer recording, the unit will automatically stop, eject the videotape, and turn itself off. To continue recording, insert a recordable tape.

Priority of overlapped settings

The unit records programmes according to priority if the timer programmes overlap.

If the starting time is same:

- The timer programming set first (PROG. 1) has priority.

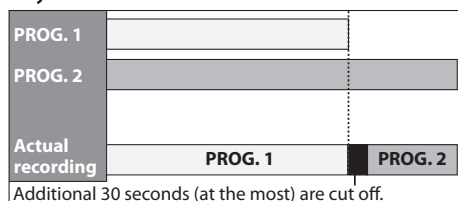

PROG. 2 recording will start after PROG. 1 recording is completed.

If programming has been made at the end of the programming (PROG. 1) currently being recorded:

- The timer programming set first (PROG. 2) has priority. PROG. 3 will not be recorded.

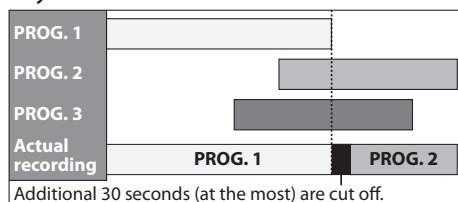

PROG. 2 recording will start after PROG. 1 recording is completed.

If the recording time is partially overlapped:

- The timer programming with the earlier start time (PROG. 2) has priority. PROG. 1 will start after PROG. 2 recording is completed.

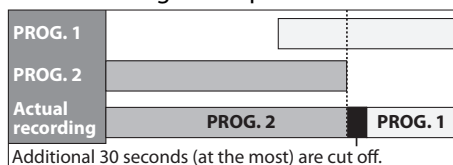

If the recording time entirely overlaps:

- The shorter timer programming (PROG. 1) is not recorded.

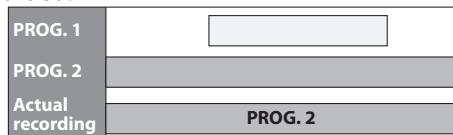

Note for DVD recording

- If the recording time of two programmes overlap, or the End time of a programme and the Start time of another is same, the first 30 seconds (at the most) of the subsequent programme are cut off.

If the End time of the programme currently being recorded and the Start time of the subsequent programme are same:

- If PROG. 1 is a DVD recorded programme, the beginning of PROG. 2 may be cut off.
- * If the cut off time exceeds 1 minute, the error number "E40" will appear in the Timer Programming list.

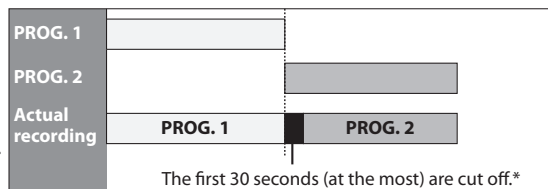

Recording

Satellite Link

You can set the unit to start recording whenever it detects the video signal from the external tuner.

Preparing for the Satellite Link Timer Recording:

Preparation on the tuner

- The external tuner should be equipped with some kind of timer function. Using timer function of the tuner, set it to be turned on when it comes to the time you want to start recording, and off when it comes to the time you want to finish recording. (Refer to the tuner's manual on how to set the timer.)
- Make sure to turn the power off when you finish setting.

Preparation on this unit

- Make sure to select the desired Recording mode beforehand.

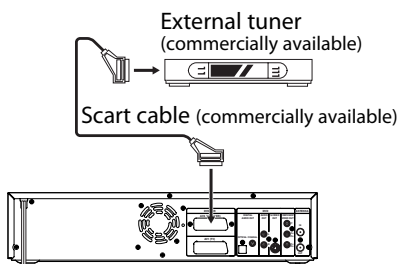

1 In stop mode, press [SETUP].

2 Select "Recording" using [Cursor ▲ / ▼], then press [ENTER].

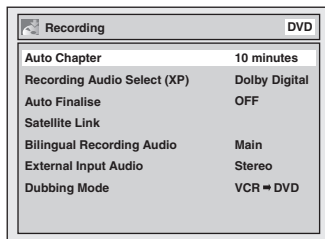

3 Select "Satellite Link" using [Cursor ▲ / ▼], then press [ENTER].

Setting menu will appear.

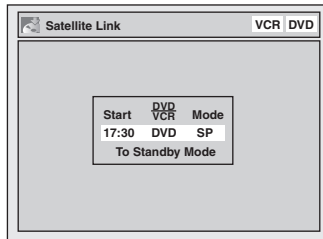

4 Select the time, media and recording mode using [Cursor ▲ / ▼], then press [ENTER].

5 Set the desired start time using [Cursor ▲ / ▼], then press [Cursor ►].

- The hour can be selected among 0-23.
- Repeat procedures in step 5 to set the desired minutes.
- If you wish to go back to the left, press [Cursor ◀].

6 Select the recording media using [Cursor ▲ / ▼], then press [Cursor ►].

7 Select the recording mode using [Cursor ▲ / ▼]. See page 24 for details.

8 Press [ENTER]. "To Standby Mode" is highlighted.

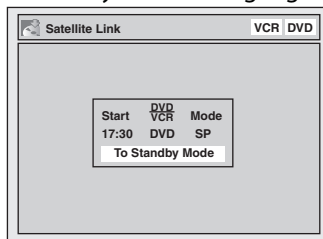

9 Press [ENTER] again.

In a second, the unit will be turned off automatically as it goes into the Satellite Link standby mode.

- Until the time you set in "Start", the clock will appear on the front panel.
- "Sat" will appear on the front panel display at the start time.



To cancel the Satellite Link function while in the Satellite Link standby mode:

Press [T-SET] to turn on the unit.

To cancel the Satellite Link function while the Satellite Link Recording is in progress:

Press [STOP ■] on the front panel of the unit.

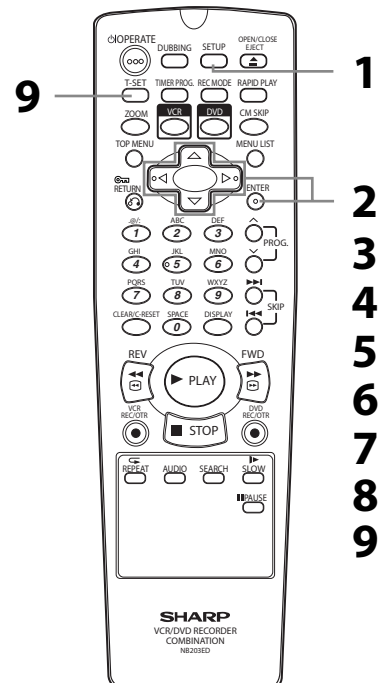









Recording

Satellite Link (cont'd)

Note

- If you have not set the clock, the clock setting window will appear at step 3. Follow to step 4 in "Clock Setting" on page 22.
- You cannot set the End time for the Satellite Link Timer Recording on this unit.
- Recording picture will be distorted if the copy protection signal is being detected during Satellite Link Timer Recording.
- When a regular Timer Recording and the Satellite Link Timer Recording are overlapped, those recordings are recorded as illustrated below.

	Example 1		Example 2		Example 3
Timer Recording		Timer Recording		Timer Recording	
Satellite Link		Satellite Link		Satellite Link	
Actual Recording		Actual Recording		Actual Recording	

Settings for external equipment

Recording from external equipment



Before recording from external equipment, see page 15 for connection instructions.

1 Press [OPERATE] to turn on the unit.

Turn on the TV and be sure to select the input to which the unit is connected.

2 When you want to record to a tape:



Insert the tape with a record tab into the cassette compartment.

When you want to record to the disc:



Press [OPEN/CLOSE EJECT ▲] to open the disc tray, then place the disc to record on.

Press [OPEN/CLOSE EJECT ▲] again to close the disc tray.

3 Select the external input mode to which the external equipment is connected. (AV1, AV2, AV3 or AV4)

To use the Scart terminal or input jacks on the rear of this unit;

To select the "AV1", or "AV2", press [0], [0], [1] or [0], [0], [2] accordingly or use [PROG. ▲ / ▼].

To use the input jacks on the front of this unit;

To select "AV3", press [0], [0], [3] or use [PROG. ▲ / ▼].
To select "AV4", use [PROG. ▲ / ▼].

4 Select a recording mode using [REC MODE]. (See page 24.)

5 Press [REC/OTR] (VCR or DVD) on the unit to start recording.

6 Press the PLAY button on the external recording component.

7 For tape:
Press [STOP ■/EJECT ▲] on the unit to stop recording.

For disc:
Press [STOP ■] on the unit to stop recording.

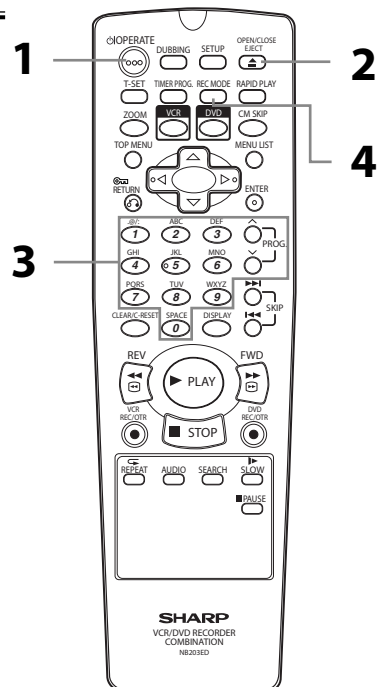

Note

- During recording, if a signal other than PAL is detected (such as NTSC), recording is paused.
- If you want to monitor the programme that you are recording, make sure the device such as Satellite Box is turned off when it is connected to AV2.

Recording

DV dubbing

Guide to DV and On-Screen Display

This function helps you to easy dubbing if you have the Digital Video camcorder that has DV output jack. You can control basic operations of the DV from the remote control of this unit such as playback, fast forward or reverse and stop all operations if the DV camcorder is in Playback mode. Use the DV cable that has 4-pin input jack and is compliance with the IEEE 1394 standards. When you connect to DV input jack on the front of this unit, select "AV4" position by using [PROG. ^ / v] and press [DISPLAY] to show the DV dubbing information for the operating your DV camcorder.

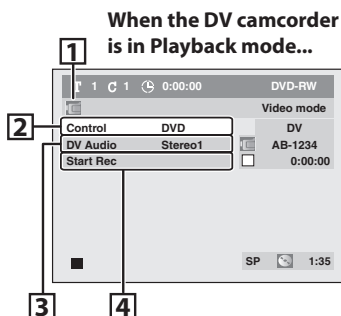

When the DV camcorder is not in Playback mode...

The menu changes according to what mode of DV Camcorder. Switch the mode on the DV Camcorder to Playback mode for the dubbing information.

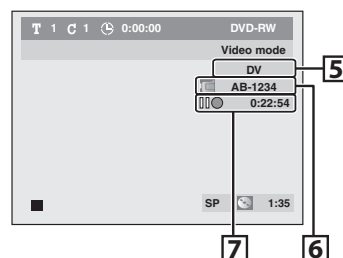

The following instructions are described with the operations using the remote control of this unit.

1 DV icon

2 Indicator of active device

- When the "Control" is highlighted, press [ENTER] to display the item selection. Select the device you wish to operate using [Cursor ▲ / ▼], then press [ENTER] to activate.
- Select "DVD" to control this unit.
- Select "DVC" to control your DV camcorder.

3 Recording audio mode

- Other than the DV camcorder is in stop mode, the "DV Audio" can be selected. Press [ENTER] to display the item selection and then using [Cursor ▲ / ▼] to select the audio you wish to output. Press [ENTER] again to activate.
- Select "Stereo1" to dub the stereo sound.
- Select "Stereo2" to dub the sound with postrecording sound.
- Select "Mix" to dub the Stereo1 and Stereo2.

4 Indicator of dubbing function

- When the unit is ready for dubbing, "Start Rec" will appear.
- When the unit is in dubbing, "Pause Rec" will appear.

5 Channel position

- When you select "AV4" by using [PROG. ^ / v], "DV" will appear.

6 Product name of your DV camcorder

- If the unit cannot recognise the input signal from the DV camcorder or the unknown product, "No Device" will appear instead.
- If the unit receives the input signal from the DV camcorder but the unknown product, "****" will appear instead.

7 Status of the current operation and the time counter

- Depending on the DVC's mechanism, the unit's counter and icons may not be displayed the same as DVC shows.

Each icon means:

- | | | | |
|--------------------------|---|-----|--|
| <input type="checkbox"/> | DVC is in stop mode. | ⏩ | DVC is fast forwarding. (in stop mode) |
| ▶ | DVC is in playback. | ⏪ | DVC is fast reversing. (in stop mode) |
| ⏸ | DVC is in pause mode. | ◀ | DVC is in reverse playback. |
| ▶▶ | DVC is fast forwarding. (standard speed) | ▶◀ | DVC is fast reversing. (standard speed) |
| ⏩⏩ | DVC is fast forwarding. (faster than above) | ▶◀▶ | DVC is fast reversing. (faster than above) |
| ⏩⏩⏩ | DVC is fast forwarding. (faster than above) | ▶◀◀ | DVC is fast reversing. (faster than above) |
| ▶▶▶ | DVC is slow forwarding. (standard speed) | ▶◀▶ | DVC is in slow reverse playback. |
| ▶▶▶▶ | DVC is slow forwarding. (faster than above) | ● | DVC is in recording. |
| ▶▶▶▶▶ | DVC is slow forwarding. (faster than above) | ⏸● | DVC is in recording pause mode. |

Recording

DV dubbing (cont'd)

Note

- The unit does not send out the output signal to DV camcorder.
- For the proper operation, connect DV camcorder to the unit directly. Do not connect this unit and the DV camcorder via any other unit.
- Do not connect more than one DV camcorder.
- The unit can only accept DV camcorder. Other DV equipment such as Set-top Box, or D-VHS VCR cannot be recognised.
- Date / time and cassette memory data will not be recorded.
- Pictures with a copy-guard signal cannot be recorded.
- A DV terminal is a terminal that can use the transmission mode conforming to the IEEE 1394 standards called "Fire Wire". It serves as the interface that connects the PC and peripheral equipment such as "i.Link" (registered trademark of SONY). It enables digital dubbing between DV devices with little degradation.
- You cannot dub from DVC to both DVD and VCR format at the same time.
- You cannot change the output mode during DVC to VCR dubbing. If you want to switch to the DVD mode, stop the VCR first.
- During DVC to VCR dubbing, you cannot change channels while paused.
- When the output is in DVD mode while playing back a DVD using AV4 (DV-IN), you cannot switch to the VCR mode.
- If you are using anything other than AV4 (DV-IN) to playback DVD, you can switch to the VCR mode, but cannot select AV4 (DV-IN) channel. (You can select AV4 (DV-IN) after switching to the DVD mode during VCR playback.)
- You cannot dub from DVC during timer standby mode.
- During timer standby of either component, you cannot select AV4 (DV-IN) even on the component which is not in timer standby.



Before recording from DV camcorder, see page 14 for connection instructions.

Insert a recordable DVD-RW/-R disc and make sure your DV camcorder is in Playback mode.



1 Select "DV" using [PROG. ^ / v].

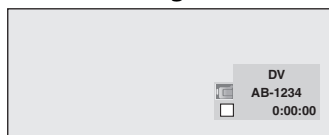

2 Select a recording mode using [REC MODE]. (See page 24.)

3 Press [DISPLAY].
DV dubbing menu will appear.

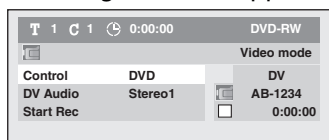

4 Press [ENTER] to display the item selection. Select "DVC" using [Cursor ▲ / ▼], then press [ENTER].

5 Press [PLAY ►] to find the point where you wish to begin the dubbing. Then, press [STOP ■] at the point you wish to start dubbing.

6 Select "Start Rec" using [Cursor ▲ / ▼], then press [ENTER].
The dubbing will start.

To pause dubbing:
Select "Pause Rec" using [Cursor ▲ / ▼], then press [ENTER].
• DVC will pause the playback and the unit will pause the dubbing.

7 Select "Control" using [Cursor ▲ / ▼], then press [ENTER].
Select "DVD" using [Cursor ▲ / ▼], then press [ENTER].
Press [STOP ■] to stop dubbing.

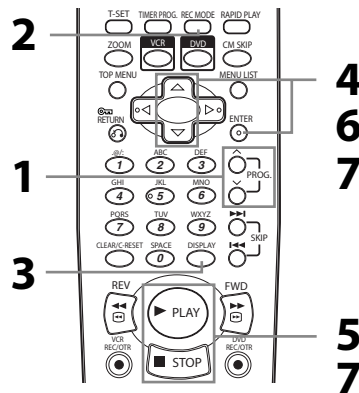

Note

- To avoid unrecorded part, the tape will rewind to the point a few seconds preceding the paused point if you select "Start Rec" whenever the DVC is in pause mode.
- If no video signal is detected from the DV camcorder during DVC to DVD dubbing, the recording will be paused and "●" will flash on the screen. The recording will resume when the unit detects a video signal again.
- When the DV camcorder is in Camera mode, refer to "Guide to DV and On-Screen Display" on page 36.

Recording

Dubbing Mode



You can copy a DVD disc to a videotape or copy a videotape to a DVD disc. This function will be available only if the DVD disc or the tape is not copy protected. Before starting this function, prepare for the recording on the DVD-RW/-R disc or the videotape. See pages 24-25, 87.

Note for recording to a tape:

- The tape's record tab is intact.
- The videotape is long enough to record the DVD disc.

Note for recording to a disc:

- The DVD disc is satisfied with the recording status.
- See pages 24-25.

Insert a disc and a tape with a record tab.

1

In stop mode, press [SETUP].

2

Select "Recording" using [Cursor ▲ / ▼], then press [ENTER].

Recording menu will appear.

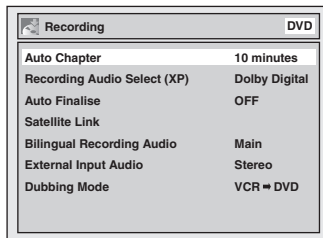

3

Select "Dubbing Mode" using [Cursor ▲ / ▼], then press [ENTER].

Option window will appear.

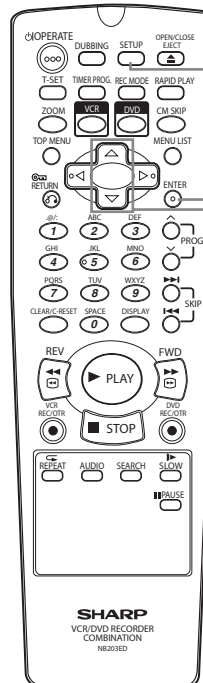
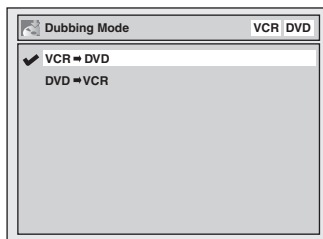

Note for VCR to DVD duplication:

- After starting VCR to DVD duplication, the picture may be distorted because of the auto tracking function. This is not a malfunction. Be advised to play back the tape until the picture is stabilized, then set the starting point which you wish to start recording, and start VCR to DVD duplication.
- This unit will automatically stop the duplication if playback with no image detected for more than 3 minutes during VCR to DVD duplication.
- If the playback sound mode of VCR is set to "STEREO", "LEFT" or "RIGHT", the sound mode upon dubbing is automatically switched to "STEREO". If the playback sound mode is set to "MONO", the sound mode upon dubbing is also "MONO".
- If you set "External Input Audio" to "Stereo", the sound is recorded in "Stereo" (both Video mode and VR mode).
- While in video mode, if you set "External Input Audio" to "Bilingual", the audio set in "Bilingual Recording Audio" mode is recorded. While in VR mode, if you set "External Input Audio" to "Bilingual", bilingual audio is recorded.
- The main and sub audio will be simultaneously recorded (VR mode). You can select audio modes during playback.

Recording

Dubbing Mode (cont'd)

VCR to DVD

- 4**
Select "VCR → DVD" using [Cursor ▲ / ▼], then press [ENTER].

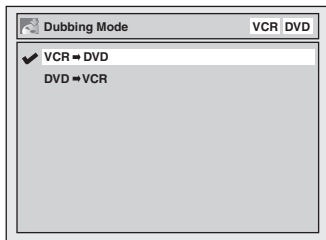

- 5**
Press [SETUP] to exit.



Press [PLAY ►] (VCR) on the unit, and then press [PAUSE ■] at the point you wish to start recording.

- 6**
Press [DVD] first.

Make sure to select a recording mode using [REC MODE]. (See page 24.)

- 7**
Press [DUBBING].
VCR to DVD duplication will start.

- 8**
Press [STOP ■] to stop the recording.

DVD to VCR

- 4**
Select "DVD → VCR" using [Cursor ▲ / ▼], then press [ENTER].

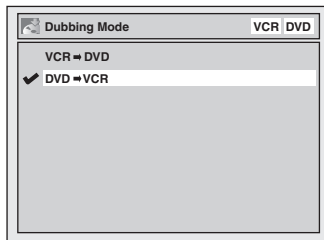

- 5**
Press [SETUP] to exit.



Press [PLAY ►] (DVD) on the unit, and then press [PAUSE ■] at the point you wish to start recording.

- 6**
Press [VCR] first.

Make sure to select a recording mode using [REC MODE]. (See page 87.)

- 7**
Press [DUBBING].
DVD to VCR duplication will start.

- 8**
Press [STOP ■] to stop the recording.

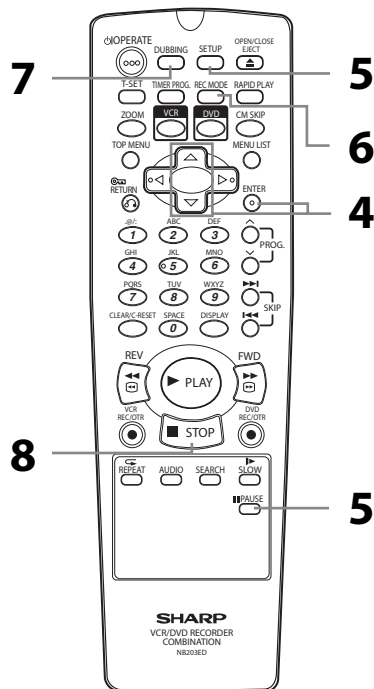

Note

- When you turn off the unit after setting the Dubbing Mode to **DVD → VCR**, the setting will be set to **VCR → DVD** automatically.
- Dubbing Mode is available only if the tape or disc is not copy protected.
- You cannot change the output mode during VCR to DVD or DVD to VCR duplication.
- If you want to watch the duplicated material, after the VCR to DVD duplication, press [DVD] first then press [PLAY ►].
- If you want to watch the duplicated material, after the DVD to VCR duplication, press [VCR] first then press [PLAY ►].

Recording

Setting a disc to protect



To prevent accidental over-recording, editing or erasing of recordings, you can protect them using the Setup menu.

Insert a recordable disc.

1

In stop mode, press [SETUP].

2

Select "Disc" using [Cursor ▲ / ▼], then press [ENTER].

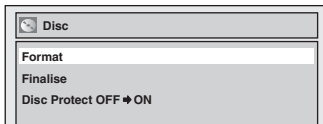

3

Select "Disc Protect OFF → ON" using [Cursor ▲ / ▼], then press [ENTER].

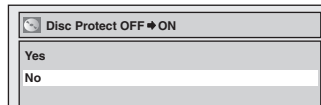

4

Select "Yes" using [Cursor ▲ / ▼], then press [ENTER]. The disc is protected.

5

Press [SETUP] to exit.

1
5

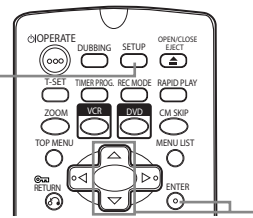

2
3
4

Note

- The Disc Protect setting is available only when a disc recorded in VR mode is inserted.
- You can select only "Disc Protect ON → OFF" when a protected disc is inserted.

To cancel the disc protect:

- Select "Disc Protect ON → OFF" at step 3, then select "Yes".
- If you insert a disc protected with this unit, "Disc Protect ON → OFF" will appear instead of "OFF → ON".

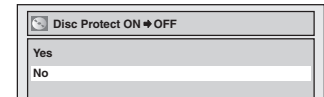

Finalising discs



You will need to finalise discs to play them back in other players. Finalising may take from several minutes up to an hour. (A disc recorded in Video mode can take up to 15 minutes. A disc recorded in VR mode can take up to 60 minutes.)

A shorter recording period on the disc will require a longer time period for finalisation. Do not unplug the mains cable during finalisation.

Insert a recordable disc before finalising.

1

In stop mode, press [SETUP].

2

Select "Disc" using [Cursor ▲ / ▼], then press [ENTER].

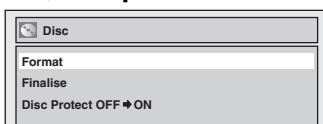

3

Select "Finalise" using [Cursor ▲ / ▼], then press [ENTER].

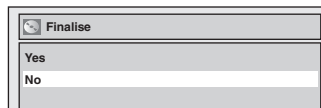

4

Select "Yes" using [Cursor ▲ / ▼], then press [ENTER]. Finalising will start.



5

Finalising is completed.

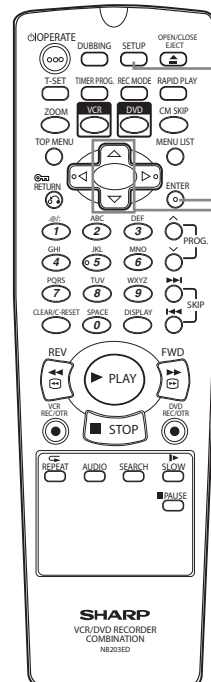

1
2
3
4

Recording

Finalising discs (cont'd)

To cancel finalising... (DVD-RW only)

Press [STOP ■] during the finalising is in progress. Select "Yes" using [Cursor ◀/▶] then press [ENTER]. Finalising is cancelled and the unit switches to stop mode.

If ⊙ appears when [STOP ■] is pressed, you cannot cancel finalising because the finalising has already reached at a critical point in its process. If "No" is selected and [ENTER] or [RETURN ↵] is pressed, finalising is continued.

You cannot cancel finalising a DVD-R disc once it has started.

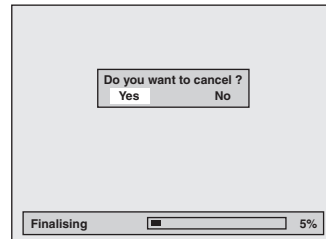

Note

- Finalising a disc in Video mode automatically creates a Title menu.
- You can use the unit to record or edit a disc recorded in VR mode even after it is finalised. After you finalise a disc recorded in Video mode, you cannot edit or record anything else on that disc.
- To release the finalisation of the DVD-RW disc, select "Undo Finalise" at step 3.
- If you insert a DVD-RW disc finalised with this unit, "Undo Finalise" will appear instead of "Finalise".
- DO NOT power off during finalising. This may result in a malfunction.

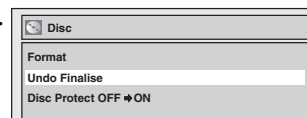

Auto finalise



You can finalise discs automatically when the disc space runs out if you set this in the Setup menu.

1
In stop mode, press [SETUP].

2
Select "Recording" using [Cursor ▲ / ▼], then press [ENTER].

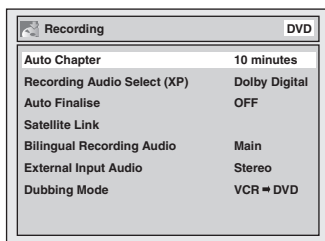

3
Select "Auto Finalise" using [Cursor ▲ / ▼], then press [ENTER].

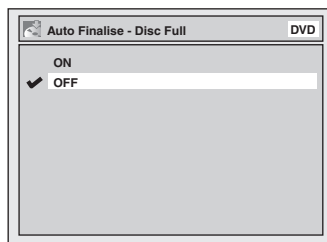

4
Select "ON" using [Cursor ▲ / ▼], then press [ENTER].

5
Press [SETUP] to exit.

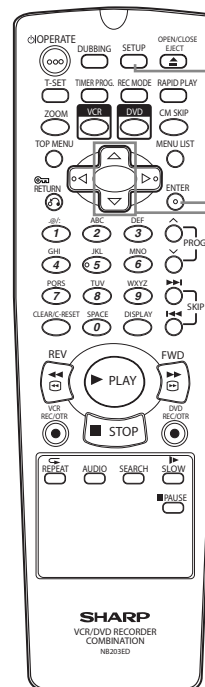

Note

- Auto finalise function is not available for discs formatted in VR mode.

Disc Playback

Information on playing back DVDs

Read the following information before you play back a DVD.

Playable discs

You can play back all the discs listed on the right. Before attempting to play back a DVD, make sure it meets the requirements for Region Codes and Colour Systems as described in this section. Discs that bear any of the logos shown below will be played back correctly in this unit. Other disc types are not guaranteed to be played back.

Colour systems

DVDs are recorded using different colour systems throughout the world. The most common colour system, used primarily in the U.K. and other EU countries, is PAL. This unit uses the PAL system. However, it is also possible to play back DVDs using other colour systems, such as NTSC.

Region codes

This unit has been designed to play back DVDs for Region Four (4). It is only possible to play back DVDs in this unit that are labelled for Region 4 or for ALL regions. You cannot play back DVDs that are labelled for other regions. Look for DVDs that bear either of the symbols shown below. If these region symbols do not appear on your DVD, you cannot play back the DVD in this unit.



The number inside the globe refers to region of the world.

A DVD labelled for a specific region can only be played back in the unit with the same region code.

Playing back on DivX® file

The unit performs Official DivX® Certified product; Plays all versions of DivX® video (including DivX®6) with standard playback of DivX® media files. Discs containing the DivX® files with the DivX® GMC (Global Motion Compensation) playback feature, which is DivX® supplemental function, cannot be played back on this unit.

Disc	Logo
DVD-Video	
DVD-RW (VIDEO / VR mode, DivX® files)	
DVD-R (VIDEO mode, DivX® files)	
DVD+RW*	
DVD+R*	
DVD-RAM (Only the disc with removable cartridge can be used.)	
CD-DA (AUDIO CD)	
VCD (VIDEO CD) / SVCD	
CD-RW (CD-DA FORMAT, MP3, JPEG, DivX® files)	
CD-R (CD-DA FORMAT, MP3, JPEG, DivX® files)	
Kodak Picture CD	

* There may be a disc which cannot be used or played back.

Disc Playback

Basic playback

Hint for DVD playback

The contents of a DVD are generally divided into titles. Titles are sometimes further subdivided into chapters.

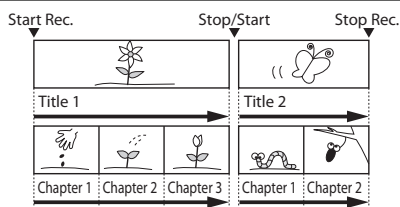

Playing back a DVD-RW / DVD-R / DVD+RW / DVD+R disc



Press first.

1 Press [OPERATE] to turn on the unit.
Turn on the TV and be sure to select the input to which the unit is connected.

2 Press [OPEN/CLOSE EJECT] to open the disc tray.

3 Place the disc on the disc tray with its label facing up. Be sure to align the disc with the disc tray guide.

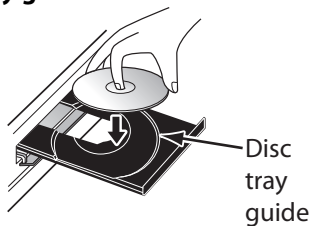

4 Press [OPEN/CLOSE EJECT] to close the disc tray.

5 Press [TOP MENU] to display the Title menu.

You can switch between the "Original" and "Playlist" in the VR mode using [MENU LIST].
<e.g. DVD-RW VR mode Playlist>

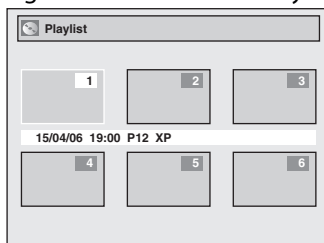

6 Select the desired title using [Cursor] / [ENTER]. Pop-up window will appear.

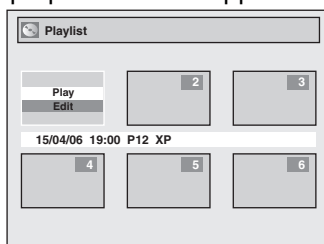

7 Select "Play" using [Cursor] / [ENTER]. Playback will start.

8 Press [STOP] to stop playback.
To eject the disc, press [OPEN/CLOSE EJECT] to open the disc tray, then remove the disc. Press [OPEN/CLOSE EJECT] to close the disc tray before turning off the unit.

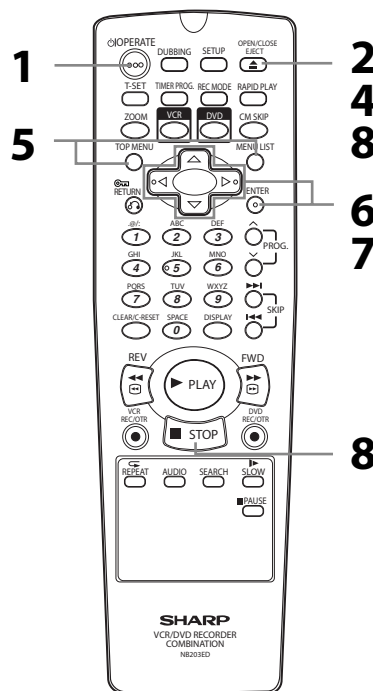

Note

- For DVD-RW (Video mode) and DVD-R (Video mode) discs that are already finalised, a title list will be displayed instead of thumbnails.
- If you insert a DVD-RW recorded in VR mode and it has a Playlist, the Playlist is displayed.
- You can resume playback from where you stopped playing back the disc (Resume playback). See page 49 for details.
- You can also start playback by pressing [PLAY] instead of [ENTER] at step 6.
- Some discs may start playback automatically.

Disc Playback

Basic playback (cont'd)

Playing back a DVD-Video / CD / Video CD



Press first.

1

Follow the steps 1 to 4 in "Playing back a DVD-RW / DVD-R / DVD+RW / DVD+R disc" on page 43.

2

Press [PLAY ▶] to start playback. Playback will start.

If you are playing back a DVD-Video or a Video CD, a menu may appear.

See pages 47-48 for details.

3

Press [STOP ■] to stop playback.

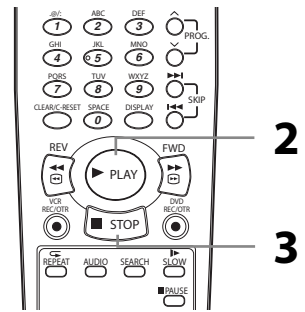

Playing back an MP3 / JPEG



Press first.

1

Follow the steps 1 to 4 in "Playing back a DVD-RW / DVD-R / DVD+RW / DVD+R disc" on page 43.

The File List will appear.

• If you are in stop mode, press [TOP MENU] to display the File List.

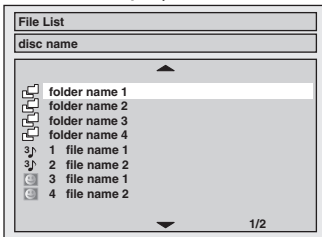

To exit the File List, press [TOP MENU] again or press [STOP ■].

2

Press [Cursor ▲ / ▼] to select the desired folder (group) or file (track), then press [ENTER].

If a file is selected:

Playback will start.

If a folder is selected:

The files in the folder will appear. Press [Cursor ▲ / ▼] to select the track or folder you want, then press [ENTER].

• Press [PLAY ▶], [ENTER] or [Cursor ▶] to move to any lower folders.

• Press [Cursor ◀] or [RETURN ↵] to move back to the folder above.

Hints for MP3 / JPEG files:

- Folders are known as Groups, files are known as Tracks.
- Folders are shown with the icon.
- MP3 files are shown with the icon. Playback will start from the selected track and continue with each one after.
- JPEG files are shown with the icon.
- The unit can recognise up to 255 groups (or folders) and up to 999 tracks.
- The name of each folder and file can be displayed using up to 29 characters. Unrecognisable characters are replaced with asterisks.
- Unplayable groups and tracks may be displayed depending on the recording conditions.
- For MP3 file recorded in Variable Bit Rate (VBR), the unit may not display the actual elapsed time.
- If there are no files in the folder, "No Files" is displayed.
- High resolution or large-size JPEG files take a few moments to be displayed.
- It is not possible to play back progressive JPEGs (JPEG files saved in progressive format) on this unit.
- It is not possible to play back JPEG files of 12MB or more.

It is recommended that files to be played back in this unit are recorded under the following specifications:

[MP3]

• Sampling frequency: 44.1kHz or 48kHz

• Constant Bit Rate: 112kbps to 320kbps

[JPEG] Size of picture

• Upper limit: 6300 x 5100dots

• Lower limit: 32 x 32dots

• Capacity limit: less than 12MB

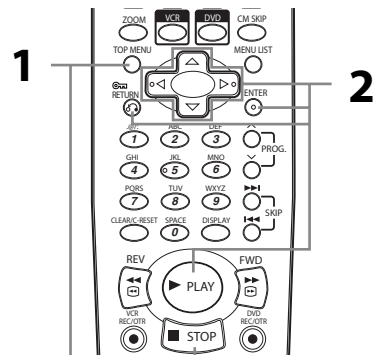

Note

- MP3 files cannot be recorded as digital sound using an MD or DAT deck.
- Files with extensions other than ".mp3 (MP3)" or ".jpg / .jpeg (JPEG)" will not be listed in the File List.
- Some folders or tracks listed in the File List may be unplayable due to their recording status.
- The File List displays only up to 8 folder and file names.

Disc Playback

Basic playback (cont'd)

Kodak Picture CD

The Picture CD is a service to convert photographs taken by a conventional film camera into digital data and write the data on a CD. You can enjoy picture images on the TV set by playing back the Picture CDs. For details of Kodak Picture CD, contact a shop that provides developing service of Kodak Inc.



1 Press [TOP MENU].

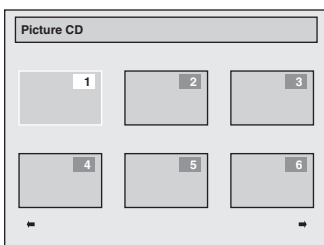

- To exit the Picture CD thumbnail List, press [TOP MENU] again or press [STOP ■].
Arrow icons mean the title list includes a next or previous page. Press [Cursor ◀ / ▶] in the direction of the icon you wish to follow. You can also quick review the six thumbnails at once between the first and last pages by pressing [SKIP ◀◀ / ▶▶].

- 2 Press [Cursor ▲ / ▼ / ◀ / ▶] to select a desired track to be played back, then press [PLAY ▶] or [ENTER].
An image will be played back from the selected track and go to the next one in turn.
- 3 Press [STOP ■] to stop playback.

Notes on JPEG and Kodak Picture CD:

After track is displayed for 5 seconds or 10 seconds (set in the "Slide Show") the display moves to the next track. During JPEG or Kodak Picture CD playback, press [Cursor ▶] or [Cursor ◀] to rotate a picture 90 degrees clockwise or counterclockwise respectively. (Not available when the display menu appears.)

Playing back a DivX®



1 Follow the steps 1 to 4 in "Playing back a DVD-RW / DVD-R / DVD+RW / DVD+R disc" on page 43. The File List will appear.

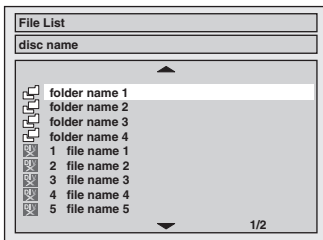

To exit the File List, press [TOP MENU] again or press [STOP ■].

2 Press [Cursor ▲ / ▼] to select the desired folder (group) or file (track), then press [ENTER].

If a file is selected:
Playback will start.

If a folder is selected:
The files in the folder will appear. Press [Cursor ▲ / ▼] to select the track or folder you want, then press [ENTER].

- Press [PLAY ▶], [ENTER] or [Cursor ▶] to move to any lower folders.
- Press [Cursor ◀] or [RETURN ♂] to move back to the folder above.

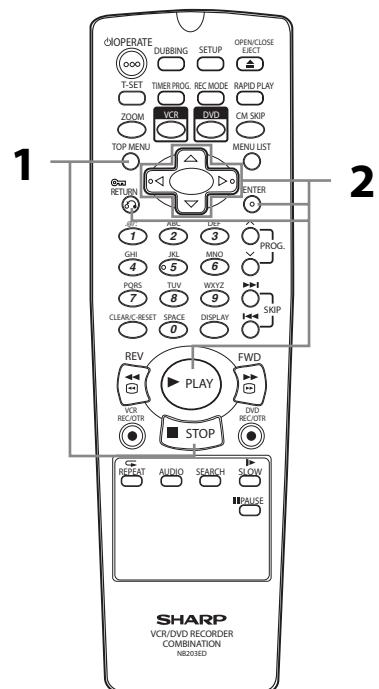

Disc Playback

Basic playback (cont'd)

It is recommended that files to be played back in this unit are recorded under the following specifications:

[DivX®]

- Official DivX® Certified product
- Plays all versions of DivX® video (including DivX®6) with standard playback of DivX® media files
- Maximum size of image : 720 x 480 @30fps
720 x 576 @25fps
- Sampling frequency of audio: 8kHz-48kHz
- Audio type : MPEG1 audio layer 3 (MP3),
MPEG1 audio layer 2,
Dolby Digital

Hint for the purchased or rental Official DivX® Certified product

- When you purchased or rental a DivX® file through the DivX® Video-On-Demand (VOD) services, a registration code is required every time you get the new file from the DivX® VOD services. Refer to "DivX® VOD" on page 59.
- Some DivX® VOD files are restricted with the limited playable times (you cannot play them back beyond the limit). If your DivX® VOD file has such limit, the playback confirmation screen will appear.

Use [Cursor ◀/▶] to select "YES" if you want to play back the file, or to select "NO" if you do not wish to play it back. Then, press [ENTER] to confirm the selection.

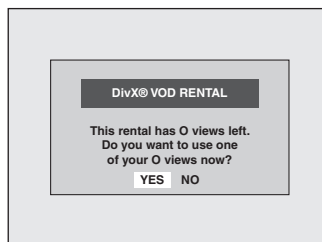

- You cannot play back the DivX® VOD files, of which rental period has been expired. In such case, press [TOP MENU] and select other files that can be played back.

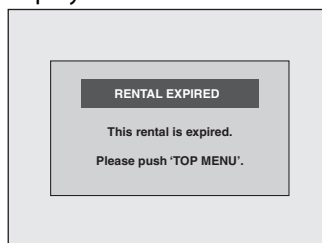

Hint

- DivX® is a codec (compression/decompression) that can compress images to a very small amount of data. The software can compress video data from almost any sources to the size that can be sent on the Internet without compromising visual quality of the images.
- A file with an extension of ".avi" and ".divx" is called an DivX® file. All files with the ".avi" extension are recognised as MPEG4.
- Files whose extension other than ".avi" and ".divx" will not be listed on the DivX® menu. However, unplayable groups or tracks may be displayed, depending on the recording conditions.
- Even if the file has an extension of either ".avi" and ".divx", this unit cannot play it back if it is recorded in the format other than DivX®.
- Folders are known as Groups; files are known as tracks.
- A symbol of  is shown on the top of the file name.
- A maximum of 255 folders or 999 files may be recognised in one disc.
- Up to 8 hierarchies can be recognised in one folder. Files in the 9th or deeper hierarchies cannot be played back.
- If the track extends beyond the scope of screen, a down arrow "▼" appears, indicating that the user can view another part on the previous page. The current page number and the number of total pages are shown on the right of the down arrow "▼".
- The name of group and track can be displayed up to 29 characters. Unrecognisable characters will be replaced with asterisks.
- You can play back the disc recorded in multi-session.
- Playback will be paused if the File List is displayed during the playback.
- It may take a while for audio and images to be output after you inserted a disc and pressed [PLAY ▶].
- When playing back the files recorded in high bit rates, the images can be interrupted in some occasions.
- Although DivX® logo has been obtained for this unit, it may not be able to play back some data, depending on the characteristics, bit rates, or audio format settings, etc.
- Use the software recognised by the DivX, Inc. when you make DivX® files.
- A DivX® file whose file size exceeds 2GB cannot be played back.
- When using tools or utilities to make up DivX® files, read their instruction manual beforehand.
- Never use the MPEG4 tools when you make DivX® files. Otherwise, noise or disturbance of the picture and sound may be generated.
- If a large-sized DivX® file is selected, it may take a while to start the playback (over 20 seconds sometimes).

Disc Playback

Basic playback (cont'd)

Hint

- If DivX® files written on CD discs cannot be played back, rewrite them on a DVD disc and try to play back.
- For more information for DivX®, please visit <http://www.divx.com>.
- If you insert a CD-RW/-R with DivX® files that are mixed with MP3 and JPEG files, the Playback Media Selection screen will be displayed. Please select "Video" and proceed to next step.



- Press **[MENU LIST]** to call up the Playback Media Selection screen in stop mode.
- If you select "Audio & Picture", instead of "Video" on the Playback Media Selection screen, this unit can play back MP3 / JPEG files.
- You cannot play back the DivX® VOD files obtained with different registration codes on this unit. Press **[TOP MENU]** and select other files that can be played back.

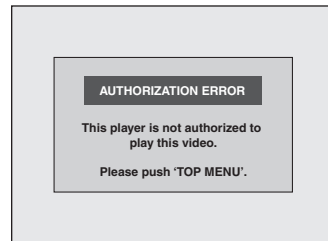

Playing back discs using the Disc menu



A DVD contains a disc menu, which lists the contents and enables you to customize playback. The menu may offer choices for subtitle languages, special features, and chapter selection. Usually this information appears automatically when you start playback, but sometimes you need to press **[MENU LIST]** to display the menu.



1

Press **[MENU LIST]**.

If the feature is not available, may appear on the TV screen.

2

Select an item using **[Cursor ▲ / ▼ / ◀ / ▶]**, then press **[ENTER]**.

Repeat this step until all the features you want are set up or to start playing back the disc from the menu. The following operations are available.

[MENU LIST] button:

Displays the DVD menu, which will vary among discs, and may be same with the Title menu.

[Cursor ▲ / ▼ / ◀ / ▶] buttons:

Move the cursor from item to item on the screen.

[ENTER] button:

Selects the currently highlighted menu option.

[the Number buttons]:

Selects a numbered menu option (available on certain discs).

3

Press **[MENU LIST]** to exit the disc menu.

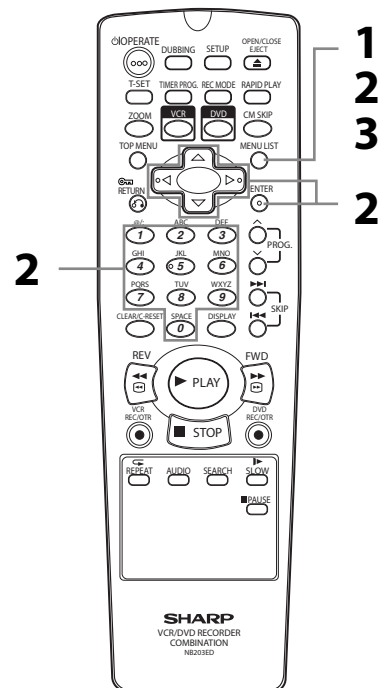

Note

- Menus vary among discs. Refer to the information accompanying the disc for details.

Disc Playback

Basic playback (cont'd)

Playing back a disc using the Title menu



Some DVDs have a Title menu, which lists the titles available on the DVD. You can start playing back such discs at a specific title.



1

Press **[TOP MENU]**.

The Title menu will appear. If the feature is not available, may appear on the TV screen.

2

Select a desired item using **[Cursor ▲ / ▼ / ◀ / ▶]**, then press **[ENTER]**.

The disc will start playing back at the title you selected. The following operations are available.

[TOP MENU] button:
Displays the DVD "Title Menu" which will vary between discs.

[Cursor ▲ / ▼ / ◀ / ▶] buttons:
Move the cursor from item to item on the screen.

[ENTER] button:
Selects the currently highlighted menu option.

[the Number buttons]:
Selects a numbered menu option (available on certain discs).

3

Press **[TOP MENU]** to exit.

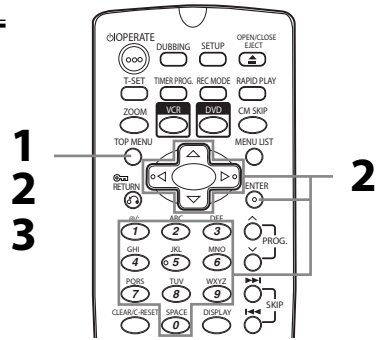

Note

- **[TOP MENU]** will not be available for some DVDs.
- Menus vary among discs. Refer to the information accompanying the disc for details.

PBC function for Video CDs



This unit conforms to ver.1.1 and ver.2.0 of the Video CD standard playback control (PBC) function. This enables you to play back interactive software using menu screens. Refer to the information accompanying the Video CD.

Ver.1.1 (without PBC function):
You can still enjoy playback of pictures and music from the CD.

Ver.2.0 (with PBC function):
"PBC ON" will appear on the screen and display when playing back a Video CD with the PBC function.

Note

- When playing back Video CDs with the PBC function, "Pbc" is displayed instead of the playing back time and current track indications on the front panel display.
- Some operations cannot be performed unless the function is cancelled either automatically or intentionally by you.
- Operations that are not available when the PBC function is set to "ON" are indicated by the following symbol in this manual:



Playing back a Video CD using the Title menu



1

When playing back a Video CD with the PBC function, the Title menu will appear automatically.

2

Press **[the Number buttons]** to select the desired title. Playback will start at the selected title.

3

Press **[RETURN]** to go back to the Title menu.

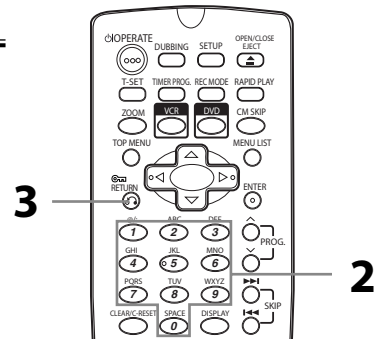

Note

- While the On-Screen Display appears, you cannot perform steps 2 and 3.

Disc Playback

PBC function for Video CDs (cont'd)

Canceling and Recalling the PBC function



Insert a Video CD.

1
In stop mode, press [SETUP].

2
Select "CD Playback Mode" using [Cursor ▲ / ▼], then press [ENTER].

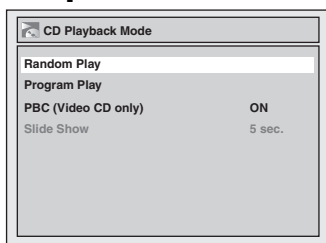

3
Select "PBC (Video CD only)" using [Cursor ▲ / ▼], then press [ENTER].

4
Select "OFF" using [Cursor ▲ / ▼], then press [ENTER].

5
Press [SETUP] to exit.
To recall the PBC function, select "ON" in step 4 above.

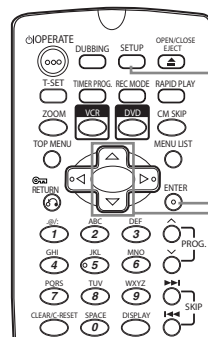

Note

- The default setting of "PBC (Video CD only)" is "ON".

Special playback

Resume playback



You can resume playback from the point where you stopped it before.



1
During playback, press [STOP ■].
The resume message will appear.

2
Press [PLAY ►].

In a few seconds, playback will resume from the point at which you stopped it before. Even if you turn off the unit, you can resume playback at the same point after turning back on the unit.

To cancel the resume playback and start playing back the disc from the beginning:

Press [STOP ■] while playback is stopped.

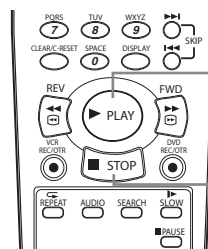

Note

- For Video CDs, if you turn PBC on using the Setup menu, the resume function is cancelled.
- For MP3 and JPEG files, playback will resume from the beginning of the track at which playback was stopped.

Disc Playback

Special playback (cont'd)

Fast forward / Fast reverse



1
During playback, press **[FWD▶▶ / ▶▶]** or **[REV◀◀ / ◀◀]**. Each time you press **[FWD▶▶ / ▶▶]** or **[REV◀◀ / ◀◀]**, the approximate speed will change as follows. Fast forward or fast reverse playback across titles (for DVDs) or tracks (for MP3) is not possible.

- For Audio CDs and MP3 files, approximate speed is fixed at x8 with sound.
- For Video CDs, approximate forward speeds are x2, x8 and x16, and approximate reverse speeds are x2, x8 and x16.
- For DivX® files, approximate forward speeds are x2, x20 and x40, and approximate reverse speeds are x5, x20 and x40.
- To return to playback at normal speed, press **[PLAY▶]**.
- Picture quality of DivX® files in fast reverse is lower than that in fast forward.
- For some DivX® files, Fast forward/Fast reverse may not function.

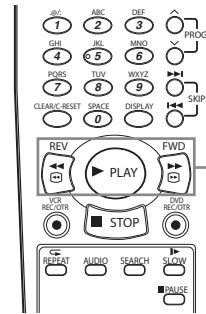

Note

- Forward/reverse speeds are indicated with icons as follows.
Forward (Approx. Speed):
x2: ▶▶
x20: ▶▶▶
x40: ▶▶▶▶
Reverse (Approx. Speed):
x5: ◀◀
x20: ◀◀◀
x40: ◀◀◀◀

Skipping TV commercials during playback



To enjoy recorded programmes without any interruptions, press **[CM SKIP]**.

1
During playback, press **[CM SKIP]**. Normal playback will start 30-second advanced point from the point at which you press **[CM SKIP]**. Each time you press **[CM SKIP]**, the start point will move another 30 seconds forward and playback resume automatically. You can press **[CM SKIP]** up to 6 times (180 seconds).

e.g. Press **[CM SKIP]** once.



(forwarding 30 seconds.)

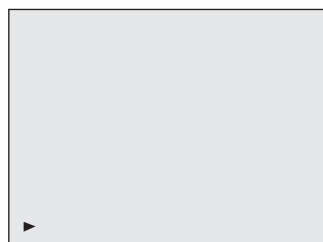

Playback will restart automatically.

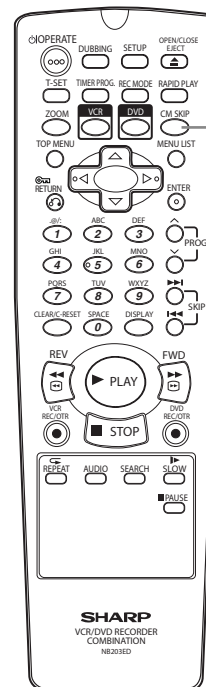

Disc Playback

Special playback (cont'd)

Pause



1
During playback, press [PAUSE].

Playback will pause with the sound muted.



2
Press [PLAY] to resume playback.

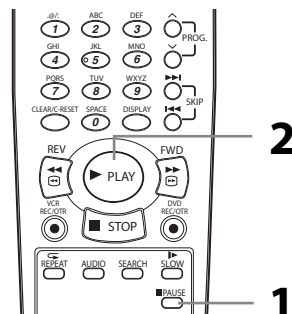

Rapid Play



Rapid Play function is available only during playback.

Available only on discs recorded in the Dolby Digital format, Rapid Play plays back in a slightly faster / slower speed while keeping the sound quality just as normal playback.



1
During playback, press [RAPID PLAY].

: Press [RAPID PLAY] once during playback. Plays back approximately at 0.8 times of normal playback.

: Press [RAPID PLAY] twice during playback. Plays back approximately at 1.3 times of normal playback.

: Press [RAPID PLAY] three times to play back in normal speed. No effects.

2
Press [PLAY] to continue the normal playback.

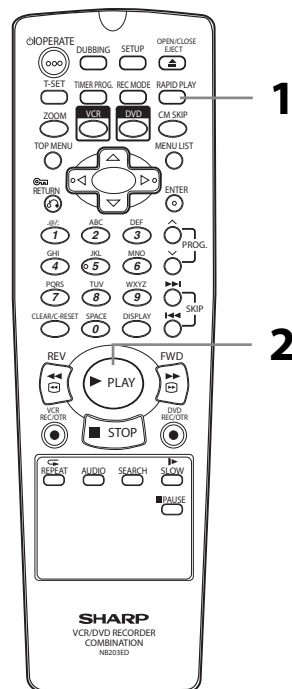

Note

- Audio (language) setting cannot be changed while using this mode.
- This feature may not work at some point in a disc.
- Audio is PCM during Rapid play mode.
- When you select "PAL" in "TV System" (see pages 83-84), this function is not available with discs recorded using the NTSC system.

Disc Playback

Special playback (cont'd)

Zoom



Press first.

1 During playback, press [DISPLAY].

Press [ZOOM] during playback, and follow from step 3.

2 Select the icon using [Cursor </>], then press [ENTER].

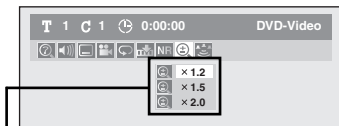

Four options are available, "x1.0", "x1.2", "x1.5" and "x2.0". These are displayed excluding the current zoom rate.

3 Select the desired zoom factor to zoom using [Cursor ▲ / ▼], then press [ENTER].

The zoom area is displayed.

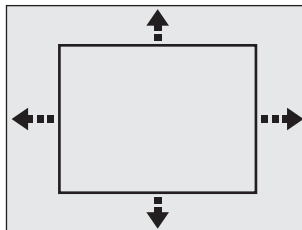

4 Select the desired zoom position using [Cursor ▲ / ▼ / </>], then press [ENTER]. Zoom playback will start.

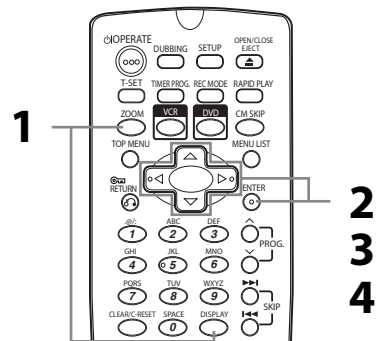

Note

- To exit the menu, press [DISPLAY].
- To cancel the zoom function, select "x1.0" using [Cursor ▲ / ▼], then press [ENTER].
- If selecting a smaller factor than that currently selected, the zoom area is not displayed.
- You cannot slide the zoomed picture on some JPEG files.

Marker Setup



You can assign a specific point on a disc to return later.

Press first.

1 During playback, press [DISPLAY].

2 Select the icon using [Cursor </>], then press [ENTER].

Marker setup menu for DVD-Video mode

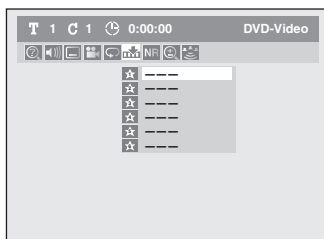

Marker setup menu for Audio CD mode

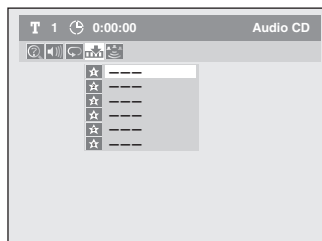

3 Select the desired marker number using [Cursor ▲ / ▼]. When the disc reaches the desired point, press [ENTER]. The title (track) number and the time are displayed.

4 To return to the marker later, select the desired marker number using [Cursor ▲ / ▼], then press [ENTER].

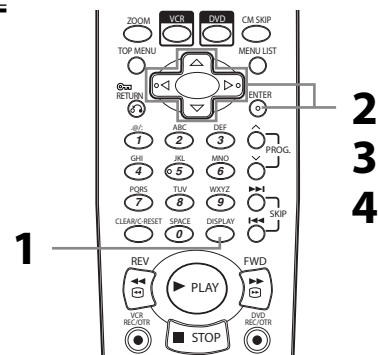

Note

- To clear a marker, select the marker number you wish to clear, then press [CLEAR/C-RESET].
- You can mark up to 6 points.
- All markers are erased when you perform the following operations.
 - Open the disc tray.
 - Turn off the power.
 - Record on a recordable disc.
 - Change the mode between Original and Playlist. (VR mode)

Disc Playback

Search

Title / Chapter search



Using [SKIP] buttons

- 1** During playback, press [SKIP] to skip the current title or chapter and move to the next. The unit moves to the next title or chapter one after the other. To go back to the previous title or chapter, press [SKIP] repeatedly.

Using the [DISPLAY] button

- 1** During playback, press [DISPLAY].
- 2** Select the icon using [Cursor] , then press [ENTER].
T for the title number is highlighted.

Searching for a Title:

- 3** Enter the desired title number to search for using [Cursor] or [the Number buttons], then press [ENTER]. Title search will start.

Searching for a Chapter:

- 3** Press [Cursor] to highlight the number displayed in the right side of the icon.
- 4** Enter the desired chapter number to search for using [Cursor] or [the Number buttons], then press [ENTER]. Chapter search will start.

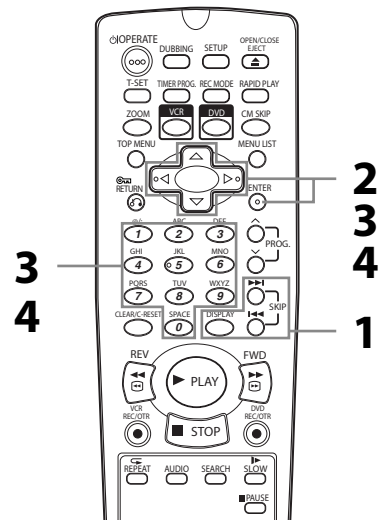

Note

- Total number of chapters and playback time of the selected title are also displayed.
- The title number and playback time of the selected chapter are also displayed.

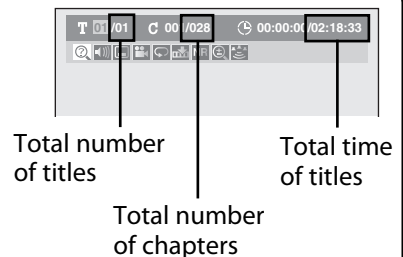

Track search



Using [SKIP] buttons

- 1** During playback, press [SKIP] to skip the current track and move to the next. The unit moves to the next track one after the other. To go back to the previous track, press [SKIP] repeatedly. The unit moves backward one track at a time.

Using the [DISPLAY] button

- 1** During playback, press [DISPLAY].
- 2** Select the icon using [Cursor] , then press [ENTER].
T for the track number is highlighted.
- 3** Enter the desired track number to search for using [Cursor] or [the Number buttons], then press [ENTER]. Track search will start.

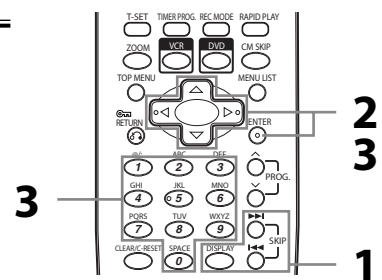

Note

- For Video CDs, you can perform the track search function in stop mode without turning PBC off manually.
- During Random playback or Programme playback, you cannot search the desired track.

Disc Playback

Search (cont'd)

Direct Search



You can search the desired track directly.



Using [the Number buttons]

1

During playback, if the display menu is not displayed, press [the Number buttons] to enter the desired track number.

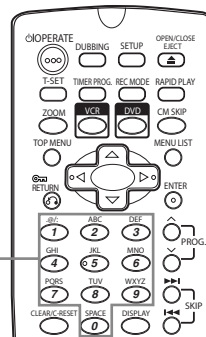

1

Note

- During Random playback or Programme playback, you cannot search the desired track directly.

Time search



1

During playback, press [DISPLAY].

2

Select the icon using [Cursor ◀/▶], then press [ENTER].

T for the title or track number is highlighted.

3

Press [Cursor ▶] to highlight the number displayed in the right side of the icon.

4

Enter the desired time to search for using [Cursor ▲ / ▼] or [the Number buttons], then press [ENTER].

Time search will start.

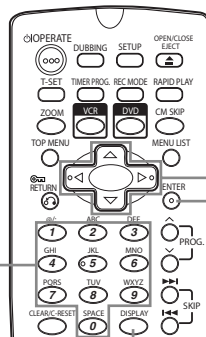

4

2

3

4

1

Note

- During Random playback or Programme playback, you cannot search the desired time.
- The title number and chapter number of the setting time are also displayed.
- Time search function is available only in the same track or title.
- If the time search is not available, there is no display.

Disc Playback

Repeat/Random/Programme playback / Slide Show

Repeat playback



1

During playback, press [DISPLAY].

Press [REPEAT] during playback, and follow from step 3.

2

Select the  icon using [Cursor ◀/▶], then press [ENTER].

3

Select the desired option to repeat using [Cursor ▲/▼], then press [ENTER].

The selected repeat playback will start.

The following operations are available.

Title:

The current title will be played back repeatedly. (DVD only)

Chapter:

The current chapter will be played back repeatedly. (DVD only)

All:

The current disc will be played back repeatedly. (DVD-RW (VR mode), CD, Video CD, MP3, JPEG and DivX® only)

A-B:

The A-B point will be played back repeatedly. (DVD, CD, Video CD and DivX® only)

When pressing [ENTER] while A-B is highlighted, A-B repeat is set.

- Press [ENTER] again to decide the starting point (A).
- Press [ENTER] after setting point (A) to select the ending point (B).

Track:

The current track will be played back repeatedly. (CD, Video CD, MP3, JPEG and DivX® only)

Group:

The current group will be played back repeatedly. (MP3, JPEG (except Picture CD) and DivX® only)

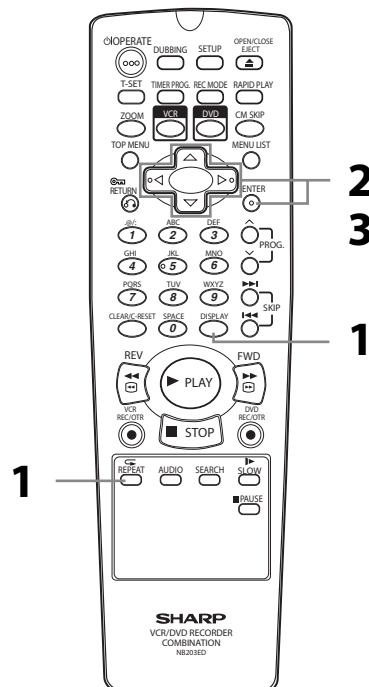

Note

- To cancel the repeat playback, select "OFF" at step 3. The repeat setting is also cancelled when you stop playback.
- You can only set A-B repeat playback within the current title (for DVDs) or current track (for Audio CDs, Video CDs and discs with DivX® files).
- You cannot select "Group" during the random playback of MP3 and JPEG files.
- For some DivX® files, A-B Repeat playback may not function.
- For Video CDs with PBC function, repeat play does not work while the PBC function is on.

Disc Playback

Repeat/Random/Programme playback / Slide Show (cont'd)

Random playback



You can use this function to play back a disc randomly instead of in the recorded order.



1
In stop mode, press [SETUP].

2
Select "CD Playback Mode" using [Cursor ▲ / ▼], then press [ENTER].

CD Playback Mode menu will appear.
<e.g. Audio CD>

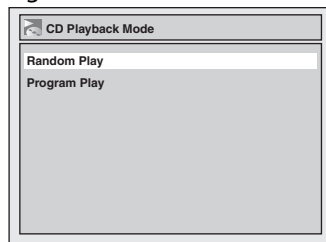

3
Select "Random Play" using [Cursor ▲ / ▼], then press [ENTER].
Random playback will start.

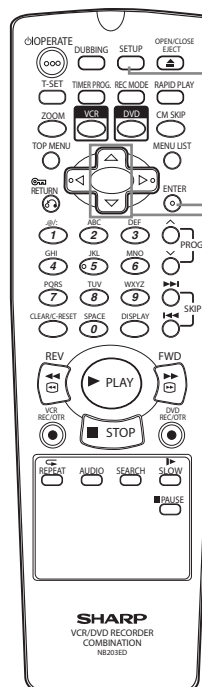

Note

- To cancel random playback, press [STOP ■] twice during random playback. "Playmode OFF" appears on the screen.
- For Video CDs with PBC function, the PBC setting will be switched to off automatically when you start random playback.
- During random playback, if you forward the track to the end, the playback speed of the next track will be normal.
- During random playback, you cannot use the search function except for the search with [SKIP ◀◀ / ▶▶]. By pressing [SKIP ◀◀], you can return only to the beginning of the current track.

Disc Playback

Repeat/Random/Programme playback / Slide Show (cont'd)

Programme playback



You can programme the disc to play back in your desired order.



1
Follow the steps 1 and 2 in "Random playback" on page 57.

2
Select "Program Play" using [Cursor ▲ / ▼], then press [ENTER].

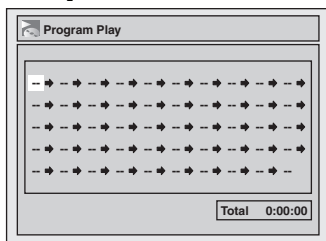

3
Select the desired track using [Cursor ▲ / ▼], then press [ENTER] or [Cursor ▶].

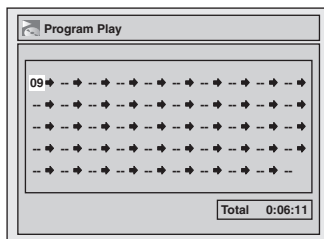

4
Press [PLAY ▶] to start programme playback.

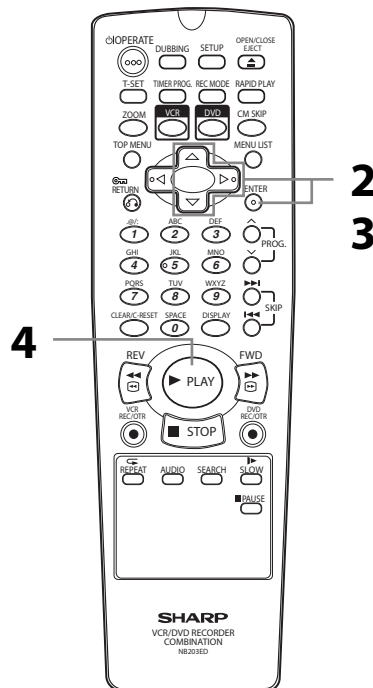

Note

- To erase tracks you selected, press [CLEAR/C-RESET].
- You can make up to 50 track settings.
- To cancel programme playback, press [STOP ■] twice during programme playback. "Playmode OFF" appears on the screen.
- You may also select the desired track using [the Number buttons] at step 3.
- For Video CDs with PBC function, the PBC setting will be switched to off automatically when you start programme playback.
- During programme playback, if you forward the track to the end, the playback speed of the next track will be normal.
- During programme playback, you cannot use the search function except for the search with [SKIP ◀◀ / ▶▶].

Slide Show



You can select the display time between 5 seconds and 10 seconds.



1
Follow the steps 1 and 2 in "Random playback" on page 57.

2
Select "Slide Show" using [Cursor ▲ / ▼], then press [ENTER].

3
Select the display time using [Cursor ▲ / ▼], then press [ENTER].

4
Press [SETUP] to exit.

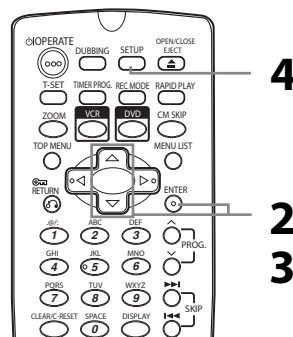

Note

- Large-size JPEG files take a few moments to be displayed.

Disc Playback

Repeat/Random/Programme playback / Slide Show (cont'd)

DivX® VOD



This unit allows you to play back the files purchased or rented from DivX® Video-On-Demand (VOD) services. The files are available on the internet. When you purchase or rent DivX® VOD files on the internet, you will be asked to enter a registration code. This menu item provides you with the registration code.



1
In stop mode, press [SETUP].

2
Select "Playback" using [Cursor ▲ / ▼], then press [ENTER].

Playback menu will appear.

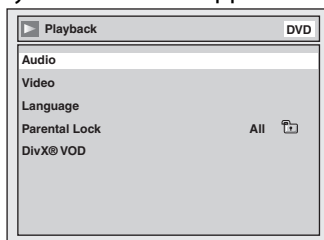

3
Select "DivX® VOD" using [Cursor ▲ / ▼], then press [ENTER].
Your registration code will appear.

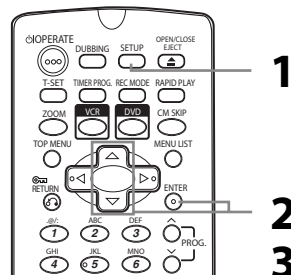
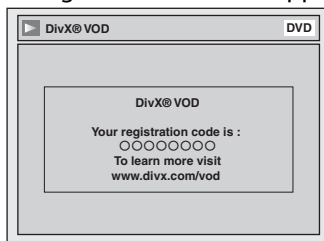

Note

- One registration code is only valid for one DivX® VOD file.
- You must first download the file from the internet and play it back on this unit before you are able to get another code.
- You must follow the steps 1 to 3 every time you purchase or rent a DivX® VOD file from the internet.
- For more information for DivX®, please visit <http://www.divx.com/vod>.

Selecting the format of audio and video

You can select the format of audio and video to suit the content of the disc you are playing back.

Switching subtitles



Many DVD-Videos have subtitles in one or more languages. The available languages are usually printed on the disc case. You can switch subtitle languages at any time during playback.



1
During playback, press [DISPLAY].

2
Select the [SUB] icon using [Cursor ◀ / ▶], then press [ENTER].

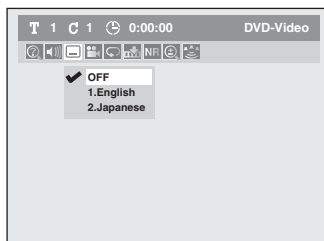

3
Select the desired subtitle language using [Cursor ▲ / ▼], then press [ENTER].
Subtitles are displayed in the selected language.
If you select "OFF", subtitles will disappear.

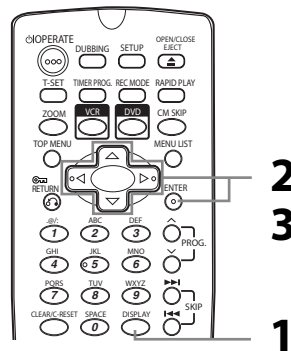

Note

- With some discs it is only possible to change the subtitle language from the disc menu. Press [TOP MENU] or [MENU LIST] to display the disc menu.
- If a 4-digit language code appears in the subtitle menu at step 3, refer to the "Language code" on page 95.
- For discs with DivX® files, the screen only displays the number of subtitle languages.

Disc Playback

Selecting the format of audio and video (cont'd)

Switching audio soundtrack



When playing back a DVD-Video recorded with two or more soundtracks (often in different languages), you can switch among them during playback.

When playing back DVD-RW discs recorded in VR mode, you can switch to main audio (L), sub audio (R) or a combination of both (L / R). When playing back Audio CDs, Video CDs or DivX® files, you can switch among the left, the right channel, and stereo.



1
During playback, press [DISPLAY].

Press [AUDIO] during playback, and follow from step 3.

2
Select the icon using [Cursor ◀/▶], then press [ENTER].

Switching virtual surround system



You can enjoy stereophonic virtual space through your exciting 2 channel stereo system.



1
During playback, press [DISPLAY].
Display menu will appear.

2
Select the icon using [Cursor ◀/▶], then press [ENTER].

Virtual Surround menu will appear.
<DVD-Video>



3
Select a desired audio soundtrack or audio channel using [Cursor ▲ / ▼], then press [ENTER].

With a DVD Video:
Audio soundtrack will switch.
Example:
English → Spanish → French

With a DVD-RW in VR mode:
Audio channel menu will appear.
Follow the step 4.

With an Audio CD, Video CD or DivX® files:

The Audio channel will switch.
Example:
STEREO → L-ch → R-ch

4
Select the desired audio channel using [Cursor ▲ / ▼], then press [ENTER].
The Audio channel will switch.

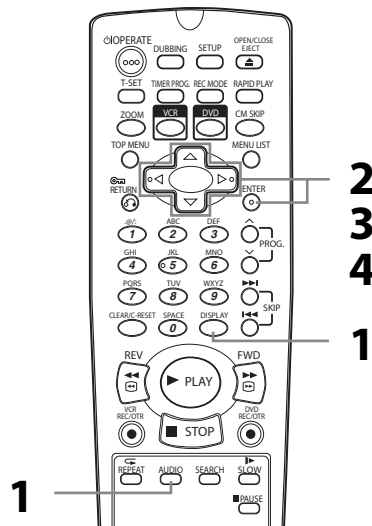

Note

- With some discs it is only possible to change the soundtrack from the disc menu. Press [TOP MENU] or [MENU LIST] to display the disc menu.

<DVD-RW VR mode>



<Audio CD>

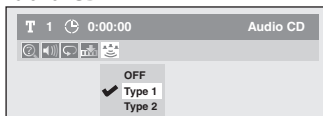

<MP3 files>

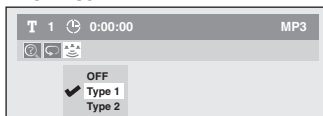

3
Select "OFF", "Type 1" or "Type 2" using [Cursor ▲ / ▼], then press [ENTER].

- OFF: No effect
- Type 1: Natural effect
- Type 2: Emphasised effect

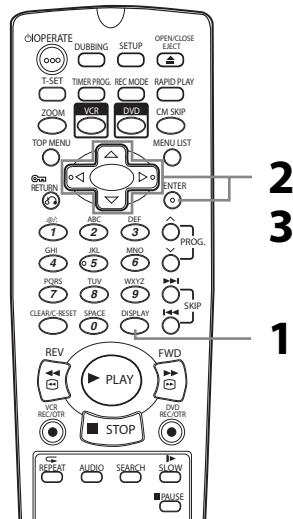

Note

- Select Virtual Surround "OFF" in a case sound is distorted.
- The setting will be kept "OFF" when the unit is turned off.

Disc Playback

Selecting the format of audio and video (cont'd)

Switching camera angles



Some DVD-Videos feature scenes shot from two or more angles. The disc case is usually marked with an angle icon if the disc has multi-angle scenes.



1
During playback, press [DISPLAY].

The angle icon appears when a switching camera angle is available. (Available only when the angle icon appears in bottom right on the TV screen.)

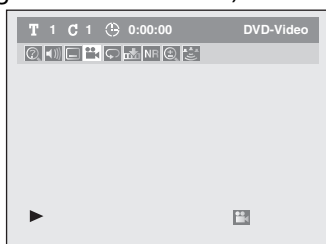

2
Select the icon using [Cursor ◀/▶], then press [ENTER].

The angle will switch each time you press [ENTER].

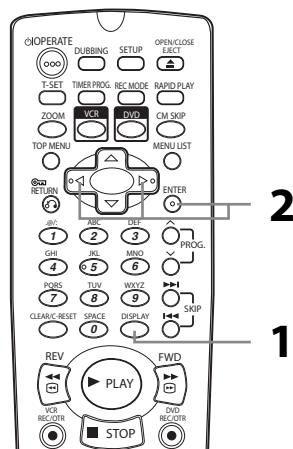

Note

- If the ANGLE ICON setting is "OFF" in the Setup menu, the icon will appear only when the disc is played back and the Display menu appears.
- Even when the icon is not displayed, you can select the angle if the currently played back title has at least two multi-angle scenes.

Reducing block noise



1
During playback, press [DISPLAY].

2
Select the icon using [Cursor ◀/▶], then press [ENTER].

Noise Reduction menu will appear.

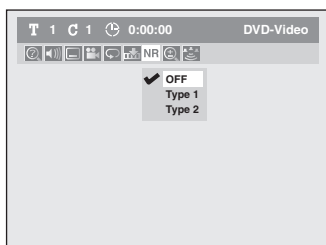

3
Select the desired option using [Cursor ▲/▼], then press [ENTER].

This function reduces noise in the playback picture.

When playing back discs recorded in long time modes such as SLP or SEP, select "Type 1" or "Type 2". "Type 2" is more effective.

When playing back discs with a little noise, such as DVD-Videos, select "OFF".

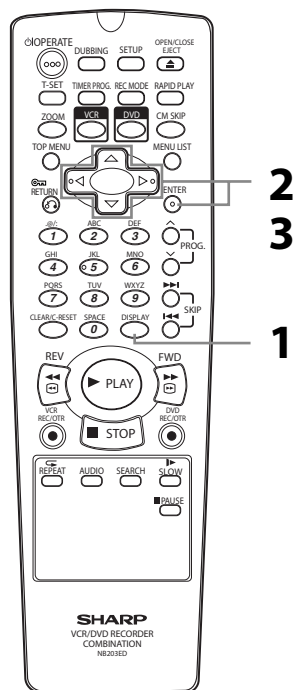

Editing

Information on disc editing

You can edit a disc recorded using the PAL system. It is not possible to edit discs recorded using the NTSC system.

Guide to a title list

The title list enables you to check the titles recorded on a disc easily. You can choose a title to play back from the screen and easily edit the titles as you wish. The items on the title list are as follows.

Press [TOP MENU].

<Main Title List>

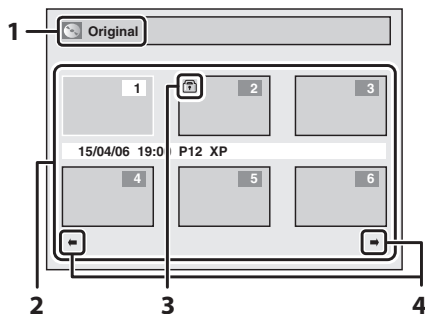

<Specific title options>

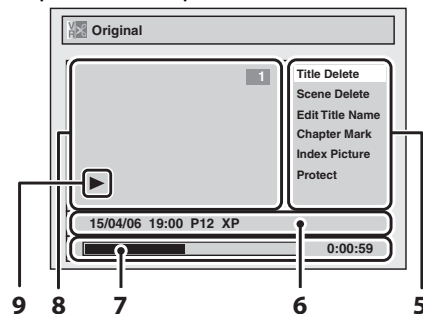

- 1 Recording format status of the current disc.
- 2 To select a title recorded on the disc for editing, move the cursor to the title and press [ENTER].
- 3 If the title is protected, the protect icon will appear.
 - It is not possible to protect a title on the Playlist.
- 4 Arrow icons mean the title list includes a next or previous page. Press [Cursor ◀ / ▶] in the direction of the icon you wish to follow. You can also quick review the six thumbnails at once between the first and last pages by pressing [SKIP | ◀◀ / ▶▶].
- 5 Available title editing menu items vary depending on the disc and format types.
- 6 You can edit the title and details as you wish.
- 7 Time status bar of the recording.
 - After editing, playback starts from this point.
- 8 The selected title from the title list thumbnails.
 - The selected title is played back automatically.
- 9 Playback status of the current disc.

Edit the recorded disc

You will find editing discs is easy. This unit offers convenient edit functions which are possible only with DVD-RW/-R discs.

You can edit the following from a title list.

- Assigning a name to a title
- Setting pictures for thumbnails
- Adding or deleting chapter marks
- Deleting titles or parts of titles

(Possible editing functions depend on the recording format and editing method.)

Original and Playlist (VR mode)

You can edit the recordings in Playlist without changing the original recordings. Playlist does not take up much disc space.

What "Original" or "Playlist" is for?

Throughout this manual, you will find Original and Playlist which refer to the actual content and the edited version.



• **Original** content refers to what's actually recorded on the disc.



• **Playlist** content refers to the edited version of the disc; how the Original content is to be played.

Finalising a Disc

- This will allow a disc that is recorded on this unit to be played back on a different DVD player - without finalisation it will not be playable on another player.
- After finalising a disc in Video mode, you cannot edit any information that is on that disc.
- If you have recorded in VR mode on DVD-RW disc, then editing is still permitted after finalising.

Editing

Information on disc editing (cont'd)

Editing discs

Type of title	Item	Page
Video Mode	Deleting titles	64
	Editing title names	65
DVD-RW VR Mode Original	Adding or deleting chapter marks	67-68
	Setting pictures for thumbnails	69
	Deleting a part of a title	70-71
DVD-RW VR Mode Playlist	Dividing a title	72
	Combining titles	73
	Adding titles to a Playlist	74
	Erasing all Playlist	75
DVD-RW VR mode Original only	Setting or releasing the title protection	76
DVD-RW Video mode only	Setting or clearing all the chapter marks in one title	77

Note

- Original titles once edited will not remain as recorded originally. When you want to leave the original as it is, edit the Playlist as you prefer.
- Once all editings are made, press **[RETURN]** in several times to exit the editing mode. "Writing to Disc" appears momentarily. It also appears when opening the disc tray or pressing **[OPERATE]** before exiting the editing mode after editing.

Notes for deleting titles

After the disc is fully recorded:

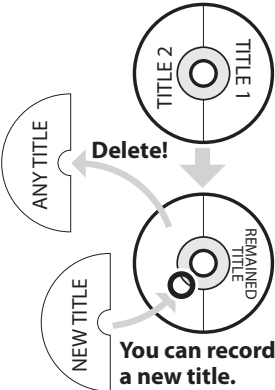
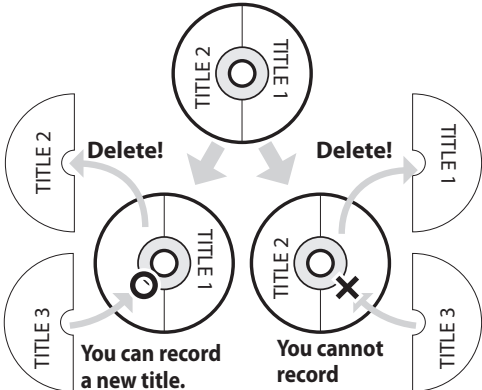
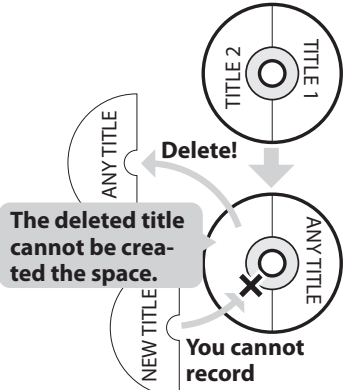
DVD-RW	DVD-R
<p>• When a title is deleted from DVD-RW disc in <u>VR mode</u>, the recordable disc space will be increased.</p> <p>The Full-Recorded disc</p> 	<p>• When the last title is deleted from DVD-RW disc in <u>Video mode</u>, the recordable space will be increased.</p> <p>The Full-Recorded disc</p> 
	<p>• When a title is deleted from DVD-R disc, the recordable space will NOT be increased.</p> <p>The Full-Recorded disc</p> 

Editing

Editing discs

Deleting titles



You can delete titles which you do not need anymore. Be advised that the titles once deleted cannot be brought back to the disc. Be sure to read "Notes for deleting titles" on page 63 before you delete the title.



1

In stop mode, press [TOP MENU]. Title list, Original or Playlist will appear.

- Press [MENU LIST] to switch between "Original" and "Playlist" if the disc is recorded in VR mode.

2

Select the desired title using [Cursor ▲ / ▼ / ◀ / ▶], then press [ENTER].

Pop-up window will appear.
<e.g. DVD-RW VR mode Playlist>

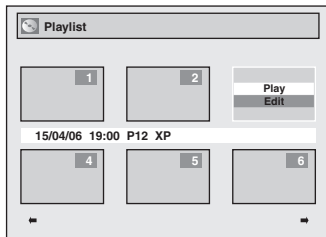

3

Select "Edit" using [Cursor ▲ / ▼], then press [ENTER].

Edit menu will appear.

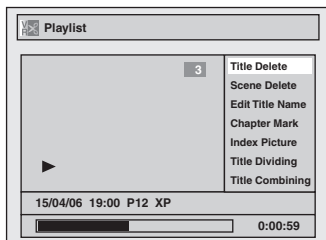

4

Select "Title Delete" using [Cursor ▲ / ▼], then press [ENTER].

Confirmation window will appear.

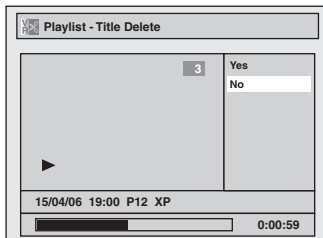

5

Select "Yes" using [Cursor ▲ / ▼], then press [ENTER].

"Are you sure?" will appear. Select "Yes" using [Cursor ▲ / ▼] and then press [ENTER].

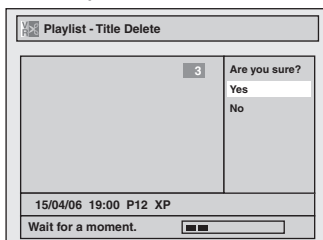

Title is deleted.

6

Press [RETURN] or [STOP] to exit.

Writing on the disc starts. It may take a while to write the data on a disc.

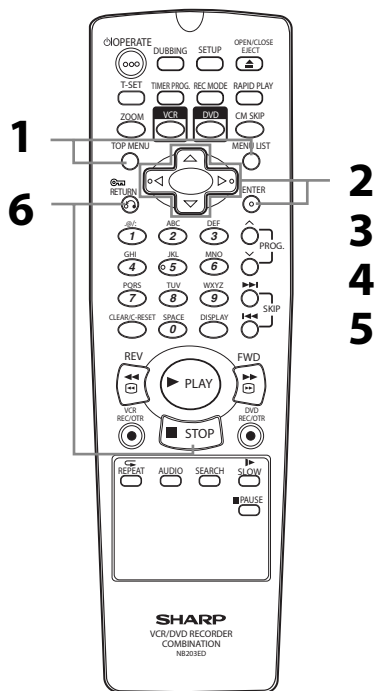

Editing

Editing discs (cont'd)

Editing title names



You can edit the title names from this menu.

The title names you edit will appear on Title List / Original / Playlist.



1

Follow the steps 1 to 3 on page 64 to display the Edit menu.

2

Select "Edit Title Name" using [Cursor \blacktriangle / \blacktriangledown], then press [ENTER].

A window for entering the title name will appear.

<e.g. DVD-RW VR mode Playlist>

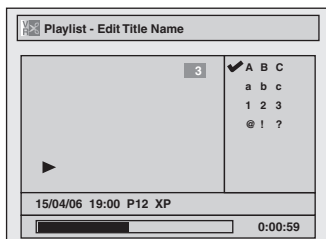

3

To enter the title name, refer to "Guide to edit title name" on page 66.

character set

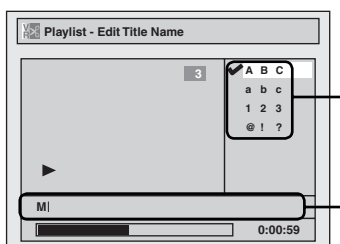

area for entering title names

When you finish entering the title name, press [ENTER].

4

Select "Yes" using [Cursor \blacktriangle / \blacktriangledown], then press [ENTER].

The name you edited becomes the title.

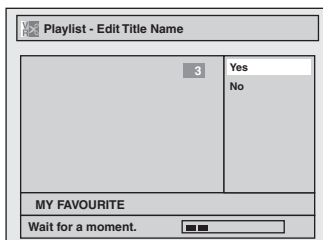

5

Press [RETURN \hookrightarrow] and then [RETURN \hookrightarrow] or [STOP \blacksquare] to exit.

Writing on the disc starts.

It may take a while to write the data on a disc.

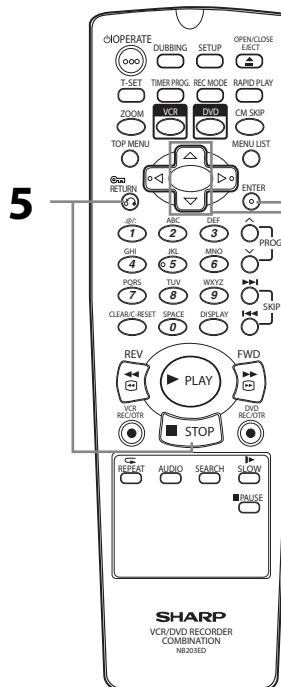

Editing

Editing discs (cont'd)

Guide to edit title name



1

Select the desired character set using [Cursor ▲ / ▼], then press [ENTER].

2

Using the list below as a guide, press [the Number buttons] repeatedly until the desired letter appears.

Select Press ✓	ABC	abc	123	@!?
0	<space>	<space>	0	<space>
1	-	-	1	!"#\$%&'() *+,-./:;<=> ?@[]^_{}
2	ABC	abc	2	-
3	DEF	def	3	-
4	GHI	ghi	4	-
5	JKL	jkl	5	-
6	MNO	mno	6	-
7	PQRS	pqrs	7	-
8	TUV	tuv	8	-
9	WXYZ	wxyz	9	-

- Characters set will be changed to the "@!?" automatically if you press 1 after you selected the "ABC" or "abc" mode.

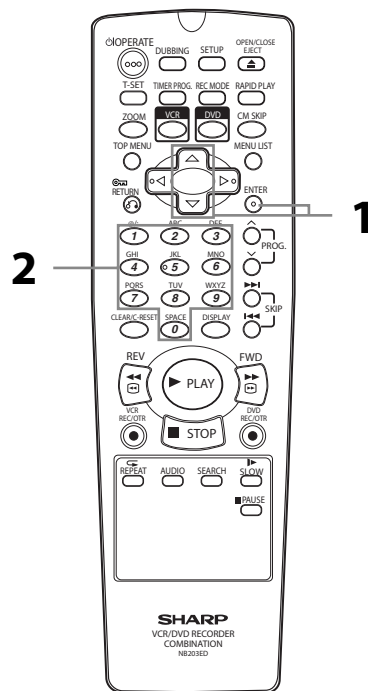

Note

- To delete letters, press [CLEAR/C-RESET] repeatedly. Press and hold [CLEAR/C-RESET] to delete all letters.
- Press [Cursor ◀/▶] to move the cursor to the left or right.
- You can enter up to 30 letters.
- Unrecognisable characters will be replaced with asterisks (*). If you delete them, adjoining characters may change to asterisks (*) or other.

Editing

Editing discs (cont'd)

Adding or deleting chapter marks



You can add chapter marks to a title. After a title is marked with chapters, you can use the chapter search feature.

You can set a chapter mark anywhere you want. You cannot set more than 999 chapter marks in the Playlist.



1

Follow the steps 1 to 3 on page 64 to display the Edit menu.

2

Select "Chapter Mark" using [Cursor ▲ / ▼], then press [ENTER].

Option window will appear.

<e.g. DVD-RW VR mode Playlist>

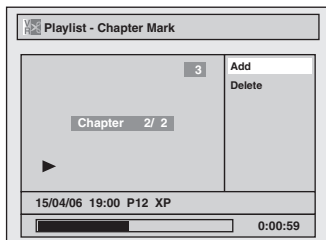

3

Use [SKIP |◀◀ / ▶▶|], [REV ◀◀ / ◀], [FWD ▶▶ / ▶], [PLAY ▶] and [PAUSE ||] to find the point where you will create a new chapter mark.

Or, use [SKIP |◀◀ / ▶▶|] to find a chapter mark that you wish to delete.

4

Select "Add" or "Delete" accordingly using [Cursor ▲ / ▼], then press [ENTER].

Confirmation window will appear.

<e.g. :Add>

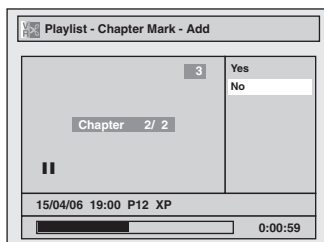

<e.g. :Delete>

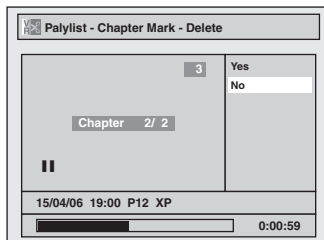

- You cannot delete the first chapter of a title.

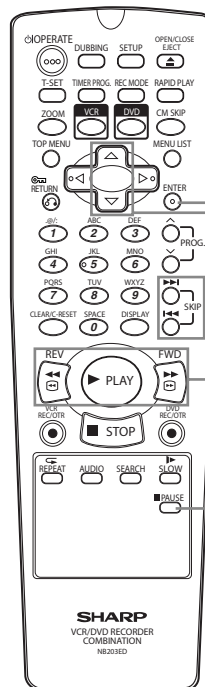

Before you start

Connections

Getting started

Recording

Disc Playback

Editing

Changing the Setup menu

VCR functions

Others

Note

- When the number of chapter marks in the Playlist comes to 999 in total, you cannot add any more chapter mark.

Editing

Editing discs (cont'd)

5

Select "Yes" using [Cursor ▲ / ▼], then press [ENTER].

Adding a chapter mark:

If you select "Add" at step 4, a new chapter mark is created at the point you specified.

<e.g. :Add>

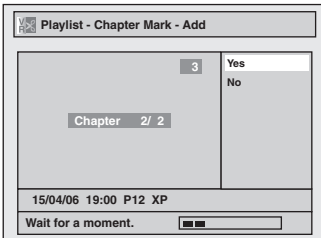

A chapter mark is added.

Deleting a chapter mark:

If you select "Delete" at step 4, the chapter mark you selected is deleted.

<e.g. :Delete>

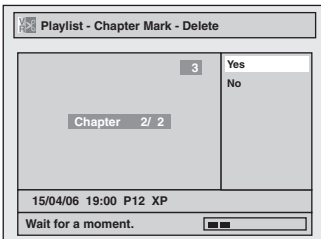

A chapter mark is deleted.

6

Press [RETURN ↵].

7

Press [RETURN ↵] again and then [RETURN ↵] or [STOP ■] to exit.

Writing on the disc starts. It may take a while to write the data on a disc.

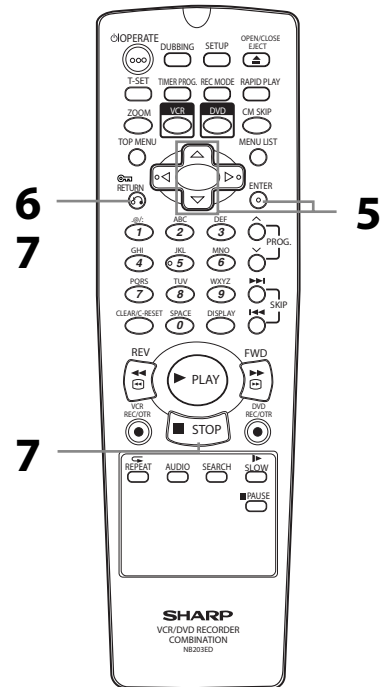

Setting pictures for thumbnails



You can set a picture as a thumbnail for each title. This helps you to remember the content of the title without having to play it back. The first picture of the title is selected as the default.



1

Follow the steps 1 to 3 on page 64 to display the Edit menu.

2

Use [SKIP |◀◀ / ▶▶|], [REV ◀◀ / ◀], [FWD ▶▶ / ▶], [PLAY ▶] and [PAUSE ||] to find the picture you want to set as a thumbnail.

3

Select "Index Picture" using [Cursor ▲ / ▼], then press [ENTER].

Confirmation window will appear.
<e.g. DVD-RW VR mode Playlist>

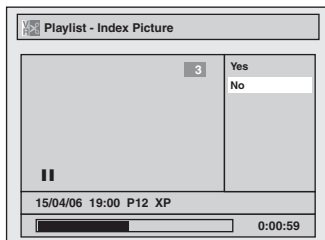

4

Select "Yes" using [Cursor ▲ / ▼], then press [ENTER].

The picture is set as the thumbnail.

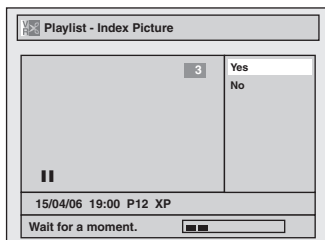

5

Press [RETURN] and then [RETURN] or [STOP] to exit.

Writing on the disc starts. It may take a while to write the data on a disc.

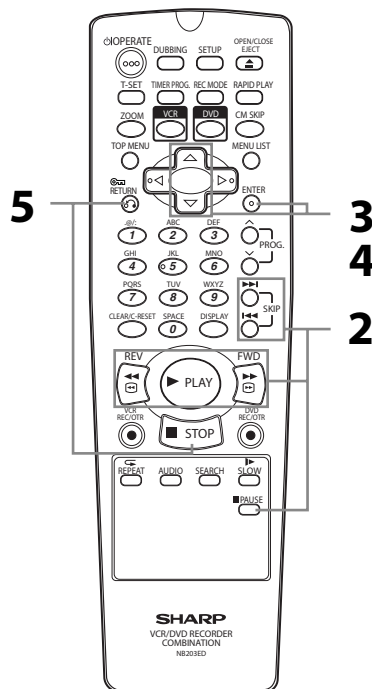

Note

- If a picture selected as a thumbnail is deleted by deleting a part of a title, the default picture is selected.

Editing

Editing discs (cont'd)

Deleting a part of a title



You can delete a specific part of a title.

Even when parts of title are deleted from the Playlist, the original title will remain as it is.



1

Follow the steps 1 to 3 on page 64 to display the Edit menu.

2

Select "Scene Delete" using [Cursor ▲ / ▼], then press [ENTER].

Option window will appear.

<e.g. DVD-RW VR mode Playlist>

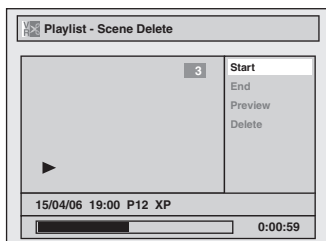

3

Use [SKIP |◀◀ / ▶▶|], [REV ◀◀ / ◀], [FWD ▶▶ / ▶], [PLAY ▶] and [PAUSE ||] to find the start point, then press [ENTER].

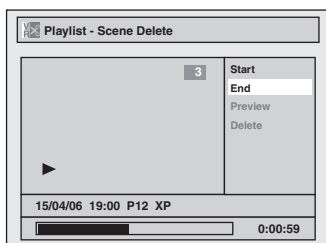

Then use [SKIP |◀◀ / ▶▶|], [REV ◀◀ / ◀], [FWD ▶▶ / ▶], [PLAY ▶] and [PAUSE ||] again to move to the end point, and press [ENTER].

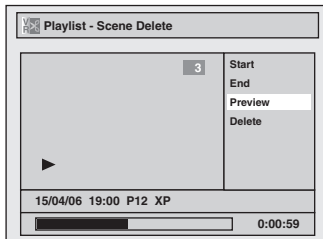

The cursor will move to "Preview". You can check the preview by pressing [ENTER].

The bar at the bottom of the screen indicates the total and the elapsed time of the title, and the area selected for deletion is indicated in red during the preview.

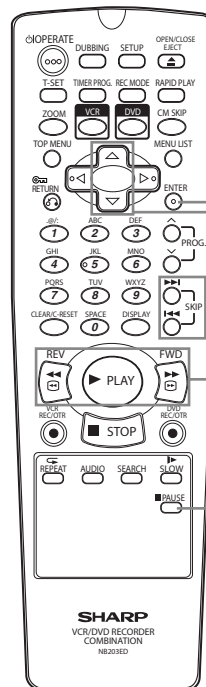

2
3
3

<Preview> Start point End point

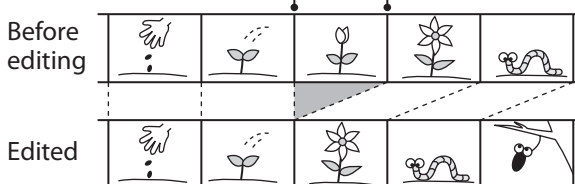

4

Select "Delete" using [Cursor ▲ / ▼], then press [ENTER].

Confirmation window will appear.

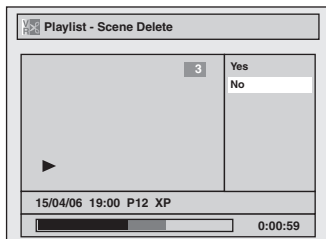

5

Select "Yes" using [Cursor ▲ / ▼], then press [ENTER].

"Are you sure?" will appear.

Select "Yes" using [Cursor ▲ / ▼] and then press [ENTER].

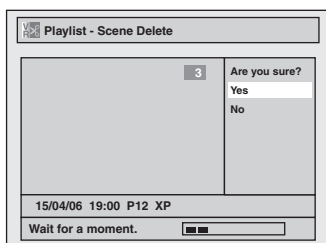

The part of the title is deleted.

6

Press [RETURN] and then [RETURN] or [STOP] to exit.

Writing on the disc starts.

It may take a while to write the data on a disc.

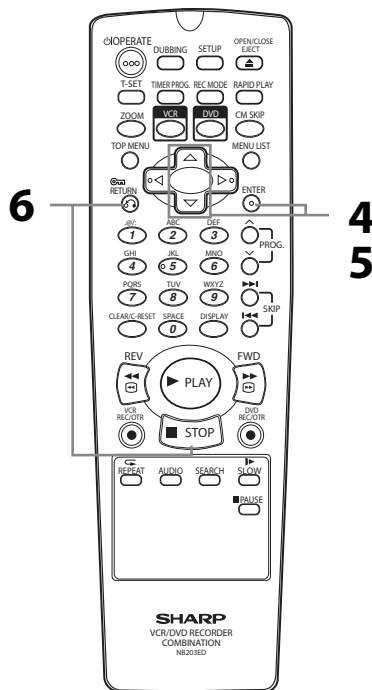

Note

- When a scene is deleted from an Original, the scene on the Playlist will also be deleted.
- You cannot select "Scene Delete" if the number of chapter marks in the Original or Playlist is more than 900.
- The recordable disc space will not increase after deleting a part of a title on the Playlist.

Dividing a title



You can divide a title into two new titles.

Press first.

1

Follow the steps 1 to 3 on page 64 to display the Edit menu.

2

Use [SKIP ◀◀ / ▶▶], [REV ◀◀ / ◀], [FWD ▶▶ / ▶], [PLAY ▶] and [PAUSE ||] to find the point where you wish to divide the title.

3

Select "Title Dividing" using [Cursor ▲ / ▼], then press [ENTER].

Confirmation window will appear.

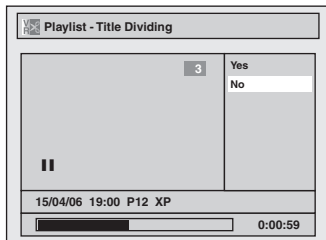

4

Select "Yes" using [Cursor ▲ / ▼], then press [ENTER].

The title is divided into two new titles with the same title names. The thumbnail you set is reset to the first picture of each title.

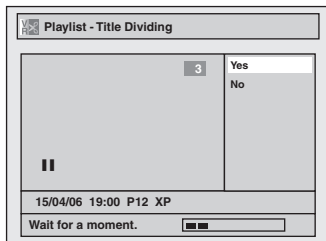

5

Press [RETURN ↵] or [STOP ■] to exit.

Writing on the disc starts.

It may take a while to write the data on a disc.

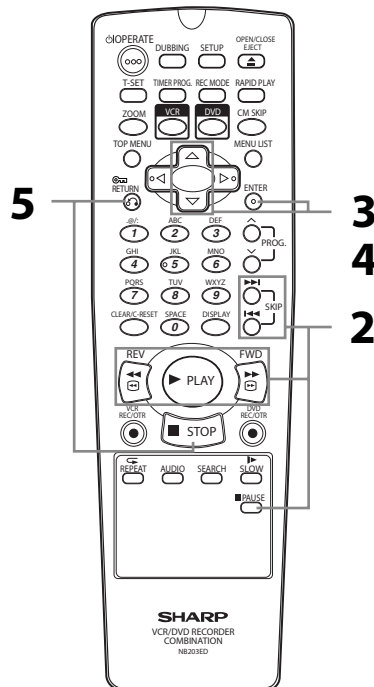

Note

- If a disc contains the maximum number of recordings (99), you cannot divide any titles.
- You cannot divide the titles if the total number of the chapters have already reached 999.

Editing

Editing discs (cont'd)

Combining titles



You can combine two titles into a single title.



1

Follow the steps 1 to 3 on page 64 to display the Edit menu.

2

Select "Title Combining" using [Cursor ▲ / ▼], then press [ENTER].

Title Combining setting window will appear.

Selected title grays out, and the frame of the next title becomes yellow.

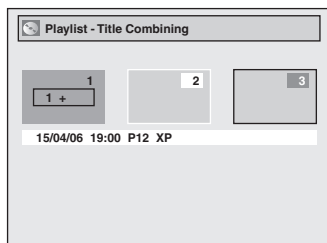

3

Select another title to combine using [Cursor ▲ / ▼ / ◀ / ▶], then press [ENTER].

Confirmation window will appear.

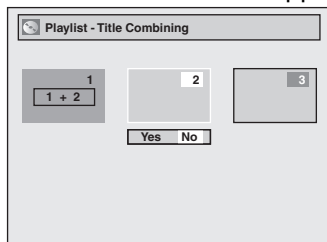

4

Select "Yes" using [Cursor ◀ / ▶], then press [ENTER].

The two titles will combine into a single title.

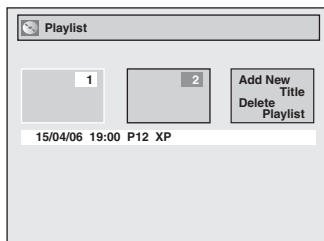
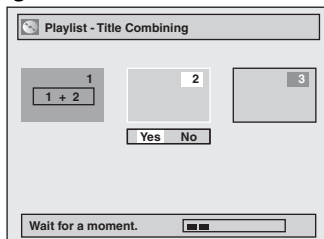

5

Press [RETURN ↵] or [STOP ■] to exit.

Writing on the disc starts.

It may take a while to write the data on a disc.

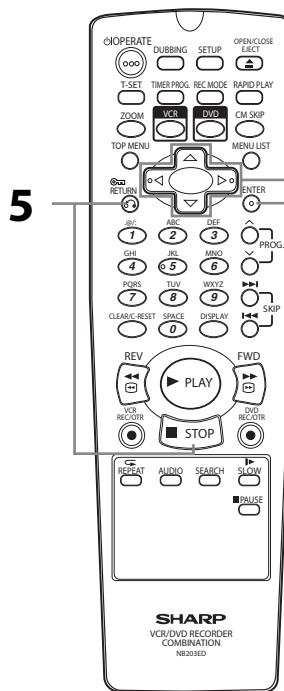

Before you start

Connections

Getting started

Recording

Disc Playback

Editing

Changing the Setup menu

VCR functions

Others

Note

- You cannot select the same title twice and combine it into a single title.
- If either one of the two original titles is deleted, the combined new title is also deleted.

Adding titles to a Playlist



You can add a title to the Playlist as you wish.

You can add up to 99 titles to a Playlist (as long as the total number of the Playlist does not exceed 999 chapters).



1

Follow the step 1 on page 64 to display the Playlist.

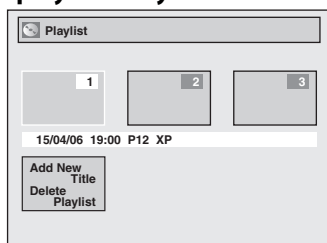

2

Select "Add New Title" using [Cursor ▲ / ▼ / ◀ / ▶], then press [ENTER].

Next to the final title, "Add New Title" "Delete Playlist" menu is shown.

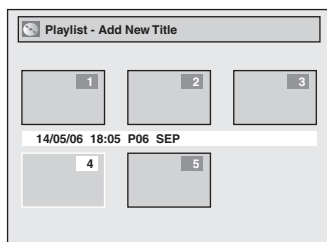

3

Select the desired title using [Cursor ▲ / ▼ / ◀ / ▶], then press [ENTER].

The added title will appear as the final title.

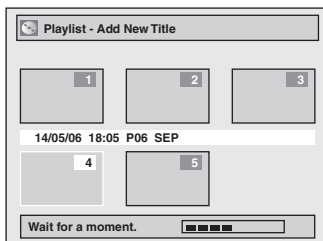

4

Press [RETURN ↵] or [STOP ■] to exit.

Writing on the disc starts.

It may take a while to write the data on a disc.

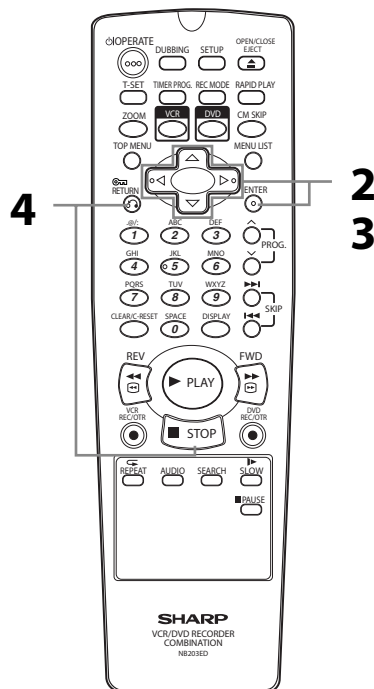

Note

- To delete a title from the Playlist, refer to "Deleting titles" on page 64.
- To delete all titles in the Playlist, refer to "Erasing all Playlist" on page 75.

Erasing all Playlist



A Playlist can be deleted if it is no longer needed.

Press first.

1

Follow the step 1 on page 64 to display the Playlist.

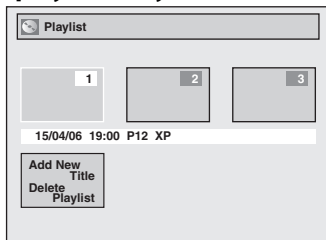

2

Select "Delete Playlist" using [Cursor ▲/▼/◀/▶], then press [ENTER].

Next to the final title, "Add New Title" "Delete Playlist" menu is shown.

Confirmation window will appear.

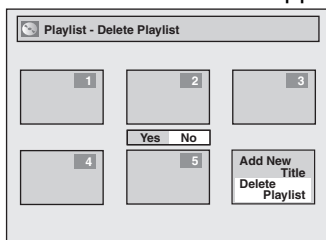

3

Select "Yes" using [Cursor ◀/▶], then press [ENTER].

"Are you sure?" will appear. Select "Yes" using [Cursor ◀/▶] and then press [ENTER].

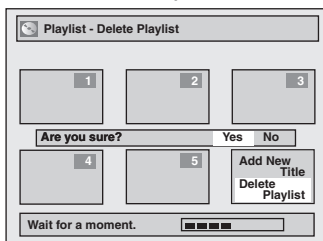

Playlist is deleted.

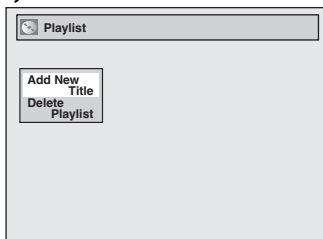

4

Press [RETURN] or [STOP] to exit.

Writing on the disc starts. It may take a while to write the data on a disc.

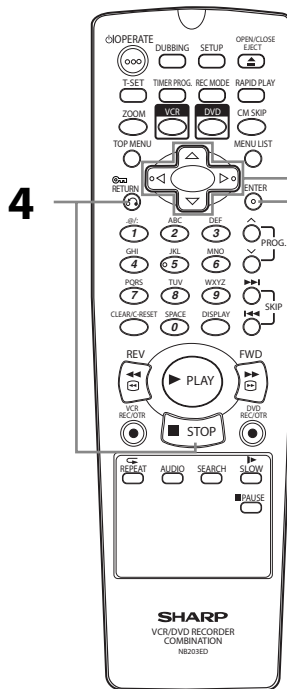

Note

- Deleting a Playlist will not increase the available recording time on the disc.
- When the disc contains 99 titles or more, or 999 chapters or more, "Add New Title" cannot be selected.

Setting or releasing the title protection



To prevent the accidental editing, or erasing of the titles, you can protect them in the Edit menu.

You can cancel the title protection feature after it is applied.

Press first.

1

Follow the steps 1 to 3 on page 64 to display the Edit menu.

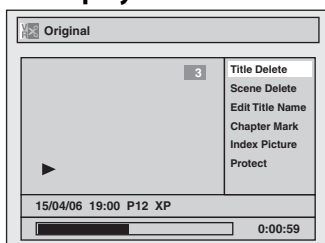

2

Select "Protect" using [Cursor ▲ / ▼], then press [ENTER].

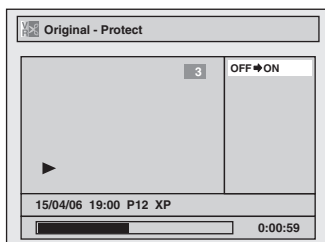

- If the title is protected, will appear in the Original list.

3

Confirm the indication "OFF → ON". Press [ENTER] again.

- If the title is already protected, "ON → OFF" will appear. If you press [ENTER], the title will be released from protection.
- icon will appear on the title in the Original list.

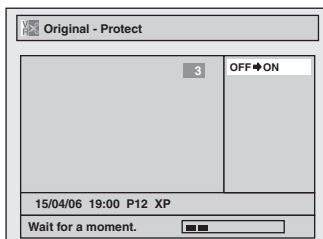

4

Press [RETURN ↵] and then [RETURN ↵] or [STOP ■] to exit.

Writing on the disc starts. It may take a while to write the data on a disc.

To protect a whole disc (DVD-RW VR mode Only):

Select "Disc Protect OFF → ON" from the Disc menu, then select "Yes".

Refer to "Setting a disc to protect" on page 40.

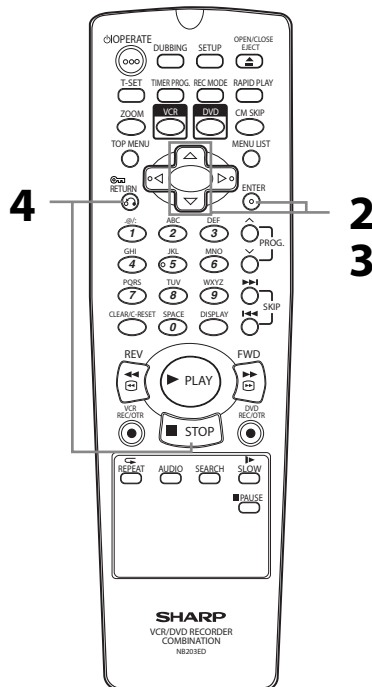

Setting or clearing all chapter marks in one title



You can add chapter marks to a title. After a title is marked with chapters, you can use the chapter search feature.

You can specify the interval of chapter marks for titles last more than 5 minutes.



1

Follow the steps 1 to 3 on page 64 to display the Edit menu.

2

Select "Chapter Mark" using [Cursor ▲ / ▼], then press [ENTER].

Option window will appear.

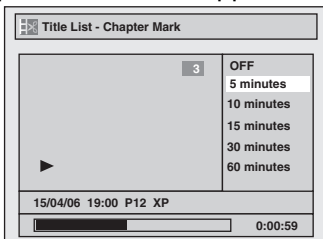

3

Select the desired interval using [Cursor ▲ / ▼], then press [ENTER].

Confirmation window will appear.

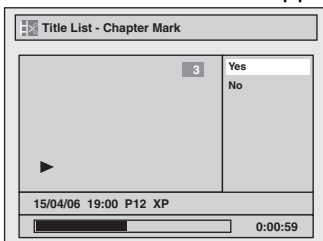

4

Select "Yes" using [Cursor ▲ / ▼], then press [ENTER].

Chapter marks are added. If you select "OFF" at step 3, all the chapter marks are erased.

5

Press [RETURN] and then [RETURN] or [STOP] to exit.

Writing on the disc starts. It may take a while to write the data on a disc.

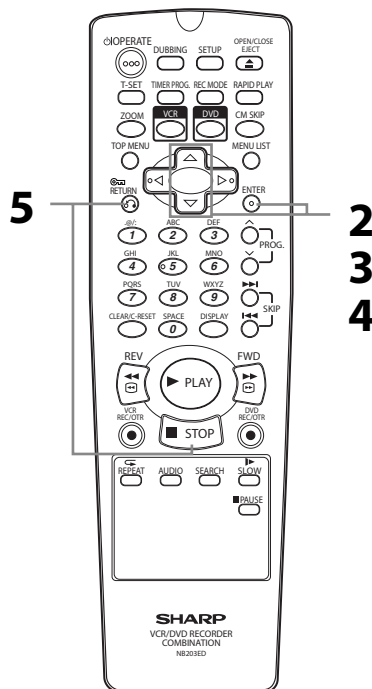

5

**2
3
4**

Note

- You cannot select a chapter mark interval that exceeds the length of a title.
- The length of chapters may slightly deviate from the one specified at the step 3.
- A chapter mark may be delayed depending on the recording content.

Changing the Setup menu

Tour of the Setup menu

The following table shows the items you can set and their default settings. Use the table as a reference for efficient operation.

Setup	Items (highlight is the default)		Contents	
1. Language setting → Pages 79-80	Disc Menu	English French Spanish ⋮	Sets the disc menu language.	
	Audio	Original English French ⋮	Sets the audio language.	
	Subtitle	OFF English French ⋮	Sets the subtitle language.	
	DivX Subtitle	OFF English French ⋮	Sets the DivX subtitle language.	
2. Display setting → Pages 80-81	OSD Language	English Français Español ⋮	Sets the On-Screen Display (OSD) language.	
	Angle Icon	ON OFF	Sets the display or undisplay of multi-angle icon in a case the DVD in playback mode contains multi-angle scenes.	
	Screen Saver	OFF 5 minutes 10 minutes ⋮	Sets the idling time before the screen saver starts.	
	FL Dimmer	Auto Bright Dark	Sets the front display brightness.	
3. Audio setting → Pages 81-83	Digital Out	PCM	48kHz 96kHz	Sets whether sound recorded at 96kHz is down sampled to 48kHz or not.
		Dolby Digital	PCM Stream	Sets the digital audio output signal specification.
		MPEG	PCM Stream	Sets the digital audio output signal specification.
		DTS	ON OFF	Sets whether DTS signal is output or not.
	Dynamic Range Control	ON OFF	Compresses the sound volume range.	
4. Video setting → Pages 83-84	Still Mode	Auto Field Frame	Sets the type of still image in pausing playback.	
	TV System	PAL Auto	Sets the TV system.	
	Video Out	SCART(RGB) Component Progressive (P) Component Interlace (I)	Sets the video output signal to be fixed accordingly to your TV set.	
5. Parental setting → Pages 85-86	Parental Lock	All level 8 to 1	Sets the DVD parental control level.	
	(Change password)	Enter the current four-digit password	Sets and changes the password.	

Note

- Changes you make to the Setup menu remain even after power to the unit is switched off or the disc tray is opened or closed.

Changing the Setup menu

Language setting

1

In stop mode, press [SETUP].

2

Select "Playback" using [Cursor ▲ / ▼], then press [ENTER].

3

Select "Language" using [Cursor ▲ / ▼], then press [ENTER].

4

Select the desired item using [Cursor ▲ / ▼], then press [ENTER].

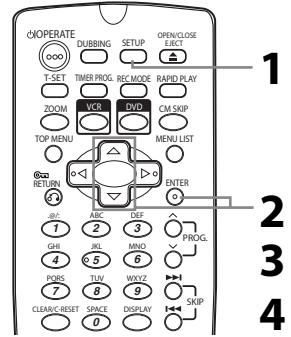

Before you start

Connections

Getting started

Recording

Disc Playback

Editing

Changing the Setup menu

VCR functions

Others

Disc Menu (Default: English)

Set the Disc Menu language.

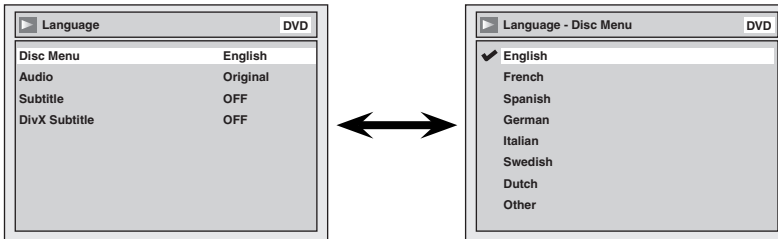

Select a setting using [Cursor ▲ / ▼], then press [ENTER].
Your setting is activated.

Audio (Default: Original)

Set the Audio language.

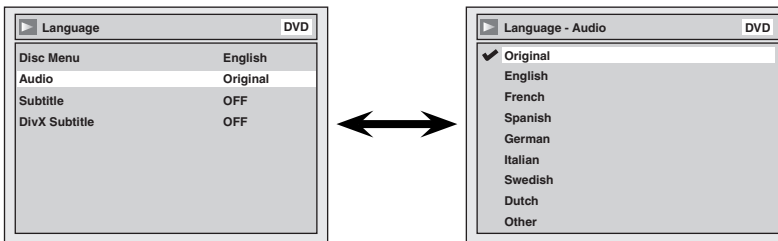

Select a setting using [Cursor ▲ / ▼], then press [ENTER].
Your setting is activated.
If "Original" is selected, the audio language is the default of the inserted disc.

Subtitle (Default: OFF)

Set the Subtitle language.

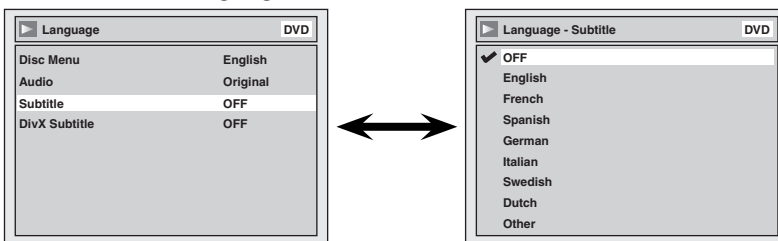

Select a setting using [Cursor ▲ / ▼], then press [ENTER].
Your setting is activated.

DivX Subtitle (Default: OFF)

Set the DivX Subtitle language.

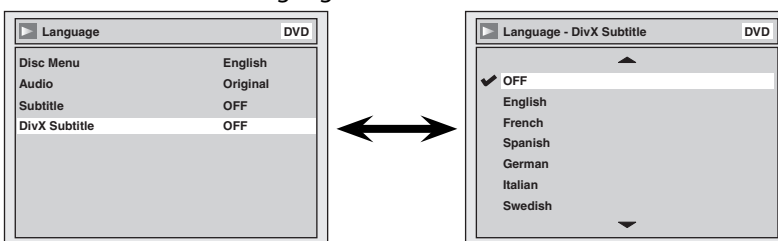

Select a setting using [Cursor ▲ / ▼], then press [ENTER].
Your setting is activated.

Changing the Setup menu

Language setting (cont'd)

If "Other" is selected, enter the appropriate 4-digit code using [the Number buttons].

Refer to "Language code" on page 95.

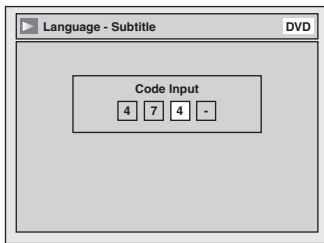

When you finish entering the code, press [ENTER].

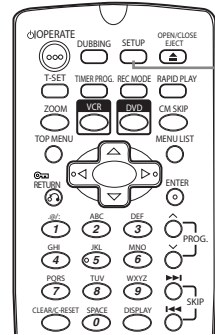

5
Press [SETUP] to exit.

Note

- You can also change or switch off the subtitles on a DVD from the disc menu if it is available.
- Press [CLEAR/C-RESET] or [Cursor ◀] to erase numbers entered incorrectly.
- You can only select the languages supported by the inserted disc.
- The Audio Language setting may not be available for some discs.

Display setting

1
In stop mode, press [SETUP].

2
Select "Display" using [Cursor ▲ / ▼], then press [ENTER].

3
Select the desired item using [Cursor ▲ / ▼], then press [ENTER].

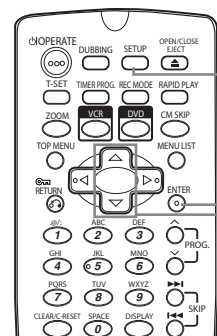

OSD Language (Default: English)

Set the OSD language.

See page 23 for details.

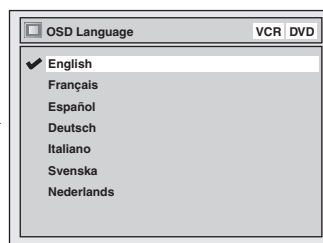
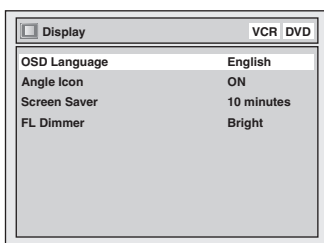

Select a setting using [Cursor ▲ / ▼], then press [ENTER].
Your setting is activated.

Angle Icon (Default: ON)

Set the angle icon.

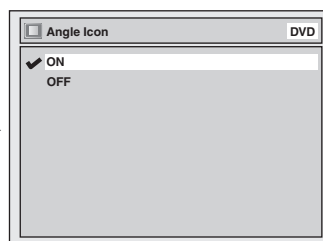
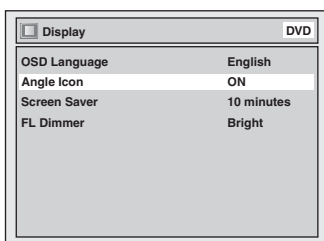

Select a setting using [Cursor ▲ / ▼], then press [ENTER].
Your setting is activated.

Changing the Setup menu

Display setting (cont'd)

Screen Saver (Default: 10 minutes)

Set the screen saver time delay.

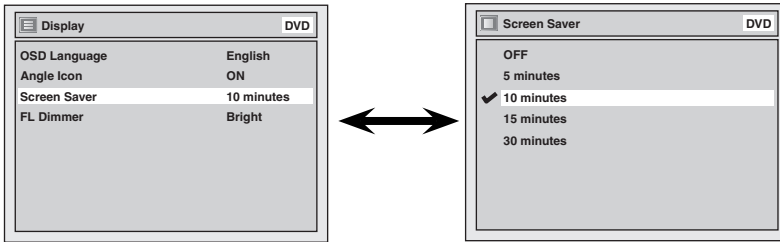

Select a setting using [Cursor ▲ / ▼], then press [ENTER].
Your setting is activated.

FL Dimmer (Default: Bright)

Set the front panel display brightness.

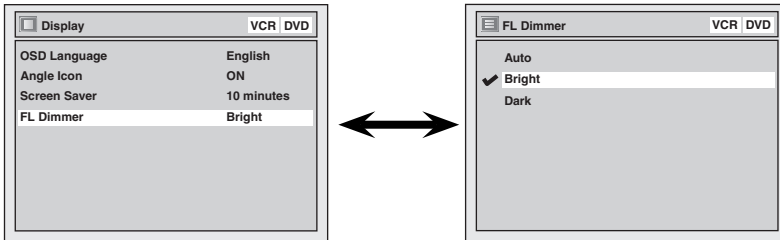

Select a setting using [Cursor ▲ / ▼], then press [ENTER].
You can choose one from "Auto", "Bright" and "Dark".
If "Auto" is selected, the display gets dark when the power is off.

4
Press [SETUP] to exit.

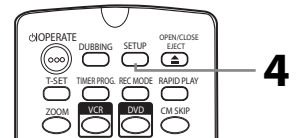

Audio setting

Choose the appropriate Audio settings for your audio equipment.
This will only affect DVDs playback.

1
In stop mode, press [SETUP].

2
Select "Playback" using [Cursor ▲ / ▼], then press [ENTER].

3
Select "Audio" using [Cursor ▲ / ▼], then press [ENTER].

4
Select the desired item using [Cursor ▲ / ▼], then press [ENTER].

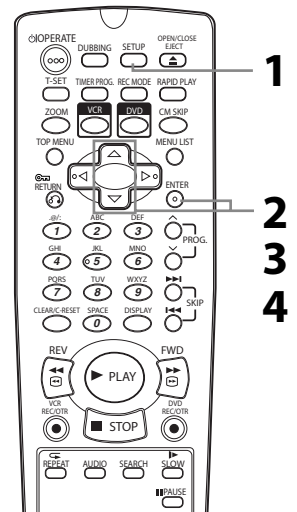

Digital Out
Set the digital audio output.

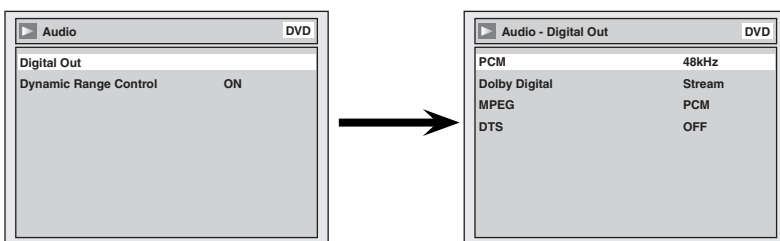

Select a setting using [Cursor ▲ / ▼], then press [ENTER].
Proceed with either of the following steps.

Changing the Setup menu

Audio setting (cont'd)

PCM sampling (Default : 48kHz)

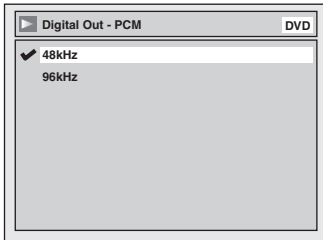

Select a setting using [Cursor ▲ / ▼], then press [ENTER].

Your setting is activated.

48kHz: If your amplifier / decoder is NOT compatible with 96kHz PCM, select "48kHz". Sound recorded at 96kHz is down sampled to 48kHz.

96kHz: If your amplifier / decoder is compatible with 96kHz PCM, select "96kHz". Sound is sampled at 96kHz.

Note

When playing back a disc with copyright protection or virtual surround system on this unit is set to "ON":

- Even if you select "96kHz", the sound is down sampled to 48kHz.

Dolby Digital conversion (Default : Stream)

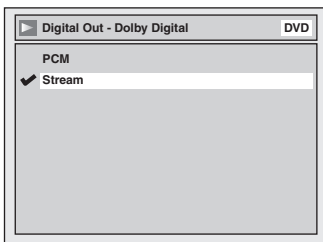

Select a setting using [Cursor ▲ / ▼], then press [ENTER].

Your setting is activated.

PCM: Converts the Dolby Digital into PCM (2 channel).
If your amplifier / decoder is NOT compatible with Dolby Digital, set to "PCM".

Stream: Outputs Dolby Digital signals.
If your amplifier / decoder is compatible with Dolby Digital, set to "Stream".

Note

When playing back a DVD-RW disc recorded in VR mode:

- If the audio source on a disc is in Dolby Digital format, set "Dolby Digital" to "PCM" so that you can switch to main audio (L), sub audio (R), or a combination of both (L / R) using your amplifier / decoder.

Settings for MPEG (Default : PCM)

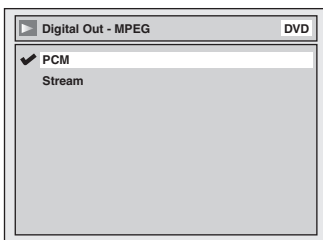

Select a setting using [Cursor ▲ / ▼], then press [ENTER].

Your setting is activated.

PCM: Converts MPEG into PCM.
If your amplifier / decoder is NOT compatible with MPEG, set to "PCM".

Stream: Outputs MPEG Audio signals.
If your amplifier / decoder is compatible with MPEG, set to "Stream".

Settings for DTS (Default : OFF)

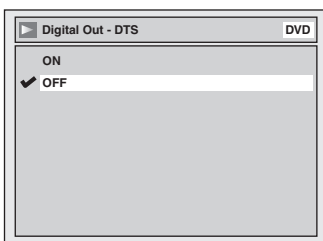

Select a setting using [Cursor ▲ / ▼], then press [ENTER].

Your setting is activated.

ON: Outputs DTS signals.
If your amplifier / decoder is compatible with DTS, set to "ON".

OFF: No DTS signal is output.
If your amplifier / decoder is NOT compatible with DTS, set to "OFF".

Changing the Setup menu

Audio setting (cont'd)

Dynamic Range Control (Default: ON)

Set to "ON" to make the dynamic range narrower.

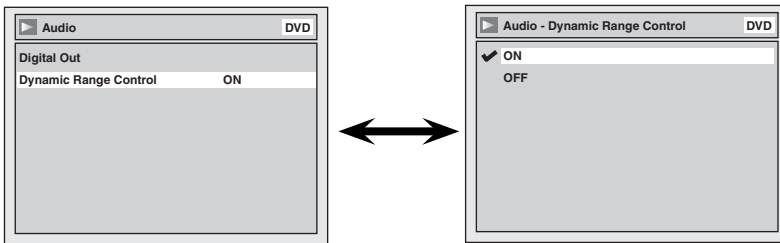

Select a setting using [Cursor ▲ / ▼], then press [ENTER].

Your setting is activated.

The Dynamic Range Control function is effective only with analogue audio connection.

5

Press [SETUP] to exit.

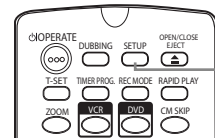

Note

- The Dynamic Range Control function is available only on discs recorded in the Dolby Digital format.

Video setting

1

In stop mode, press [SETUP].

2

Select "Playback" using [Cursor ▲ / ▼], then press [ENTER].

3

Select "Video" using [Cursor ▲ / ▼], then press [ENTER].

4

Select the desired item using [Cursor ▲ / ▼], then press [ENTER].

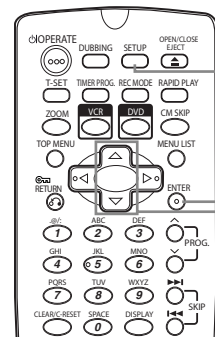

Still Mode (Default : Auto)

Set the type of still image in pausing playback.

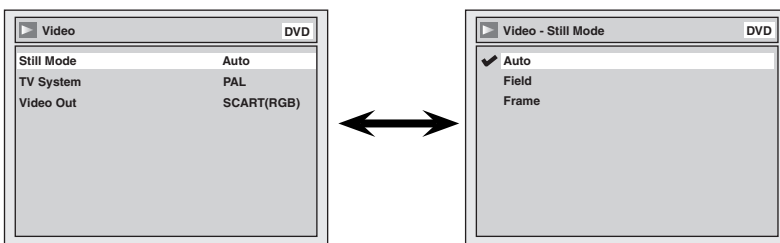

Select a setting using [Cursor ▲ / ▼], then press [ENTER].

Your setting will be activated.

Auto : Automatically select the best resolution setting ("Frame" or "Field") based on the data characteristics of the pictures.

Field : Select "Field" when the pictures are still unstable even if "Auto" is selected. "Field" stabilizes the pictures, although the picture quality may become coarse due to the limited amount of data.

Frame : Select "Frame" to display relatively motionless pictures in higher resolution. "Frame" improves the picture quality, although it may unstabilize the pictures due to simultaneous output of two Field data.

Note

- An individual picture on TV screen is called as Frame, which consists of two separate images called as Field. Some pictures may be blurred at the "Auto" setting in still mode due to their data characteristics.

Changing the Setup menu

Video setting (cont'd)

TV System (Default: PAL)

Set the TV system.

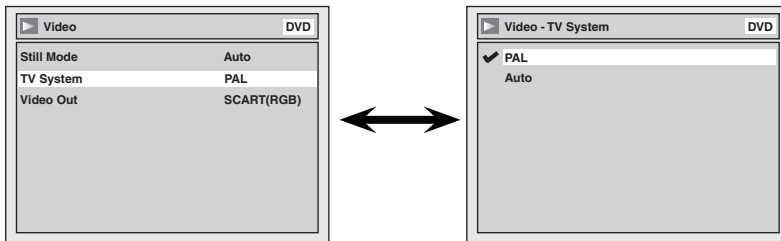

PAL: Outputs a modified PAL signal for viewing discs recorded with the NTSC system on a PAL system TV.

Auto: Changes the video system (PAL / NTSC) automatically according to the format of the inserted disc.

Select the desired system setting using [Cursor ▲ / ▼], then press [ENTER].

Note

- With discs recorded using the PAL system, a PAL signal is output for viewing on a PAL system TV.
- Discs recorded with the PAL system cannot be viewed on an NTSC system TV.
- With discs recorded using the NTSC system, an NTSC signal is output for viewing on an NTSC or Multi system TV.
- With discs recorded using the NTSC system, select PAL to view on a PAL system TV.

Video Out (Default: SCART(RGB))

Sets the video output signal to be fixed accordingly to your TV set.

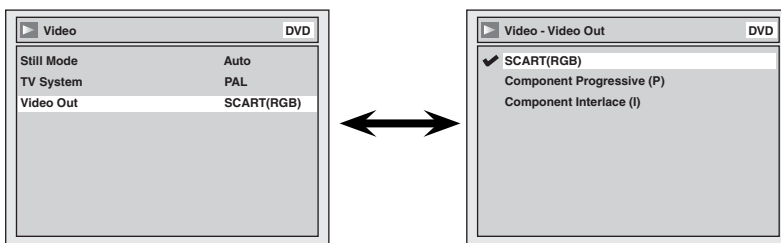

Refer to page 15 for more details.

If you select "SCART (RGB)" or "Component Interface (I)", proceed to step 5.

SCART(RGB):

Select "SCART(RGB)" if your TV has a scart terminal and connected to it.

Component Progressive (P):

If your TV is compatible with progressive scanning, select "Component Progressive (P)" and make sure the connection indicated by each jacks (Y / P_B / P_R) properly.

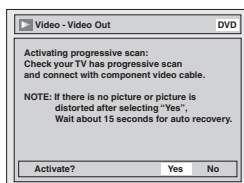

Select "Yes" using [Cursor ◀ / ▶], then press [ENTER].

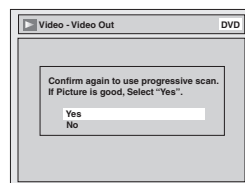

Select "Yes" using [Cursor ▲ / ▼], then press [ENTER] within 15 seconds.

Component Interface (I):

If your TV that have component jacks, select "Component Interface (I)" and make sure the connection indicated by each jacks (Y / C_B / C_R) properly.

Select the desired setting using [Cursor ▲ / ▼], then press [ENTER].

Note

- When changing the Video Out setting (SCART(RGB), Component Interlace (I) or Component Progressive (P)), connect to a VIDEO jack or an S-VIDEO jack on the TV. If the setting is changed, for example, to SCART(RGB) while the COMPONENT VIDEO OUT jacks are used to connect to the TV, a distorted video signal may be output.
- When "Component Progressive (P)" is selected, "P.SCAN" will appear on the front panel display.

5
Press [SETUP] to exit.

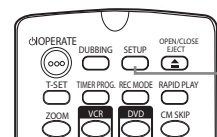

5

Changing the Setup menu

DVD-Videos Parental Lock level

Some DVD-Videos feature a Parental Lock function. If the rating of the inserted disc exceeds the level you set, playback will stop. You must enter a password before the disc will be played back. This feature prevents your children from viewing inappropriate material.

1
In stop mode, press [SETUP].

2
Select "Playback" using [Cursor ▲ / ▼], then press [ENTER].

3
Select "Parental Lock" using [Cursor ▲ / ▼], then press [ENTER].

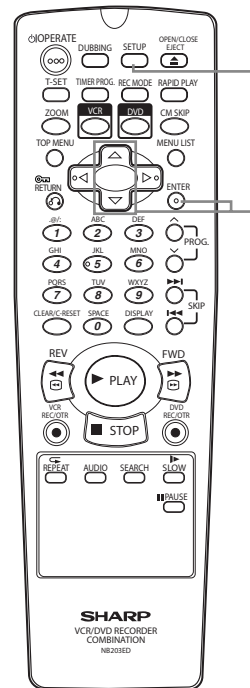

Note

- The parental lock function may not be available on some discs.
- It may be difficult to determine if some DVDs support the parental lock function. Be sure to confirm that the parental lock function operates in the way that you have set.
- Record the password in case you forget it.

Parental Lock (Default: All)

Set the Parental Lock level.

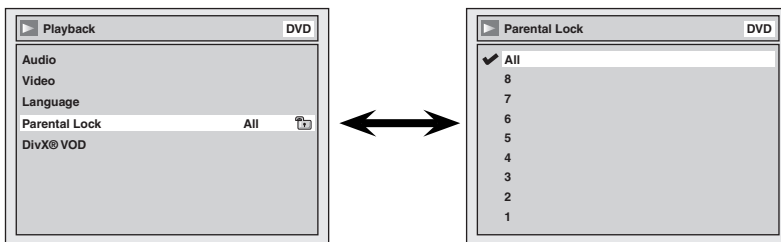

Change the Parental Lock level using [Cursor ▲ / ▼], then press [ENTER].

Proceed with either of the following steps.

- All: All parental locks are cancelled.
- 8: DVD software of any grade (adult / general / children) can be played back.
- 7 to 2: Only DVD software intended for general use and children can be played back.
- 1: Only DVD softwares intended for children can be played back.

Changing the Setup menu

DVD-Videos Parental Lock level (cont'd)



A password is not yet set

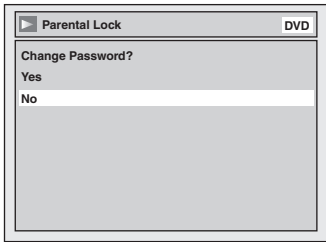

Yes →

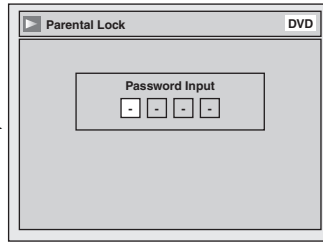

Select "Yes" using [Cursor ▲ / ▼], then enter a new password using [the Number buttons], then press [ENTER].

Your setting is activated.

If you select "No", proceed to step 4.



A password is already set

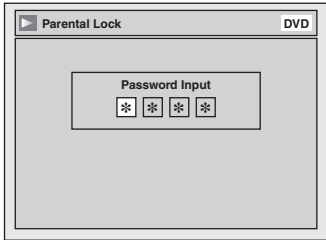

→

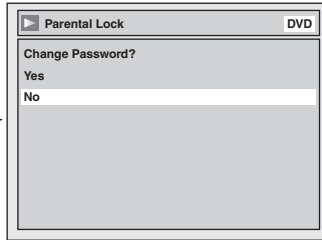

Yes →

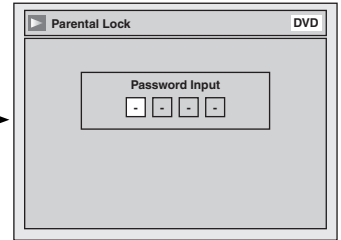

Enter the current password using [the Number buttons].

Change the password.

Select "Yes" using [Cursor ▲ / ▼], then enter a new password using [the Number buttons], then press [ENTER].

Your setting is activated.

If you press [ENTER] without entering a password, you can set up without a password.

4

Press [SETUP] to exit.

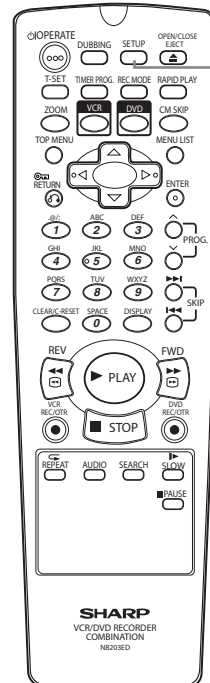

4

Note

- Press [CLEAR/C-RESET] to erase numbers entered incorrectly.
- If you forget your password or you want to clear all settings in Parental Lock, enter [4], [7], [3], [7] using [the Number buttons] at the option window. Your password is cleared and parental levels are set to "All".

VCR functions

Playback



Press first.

- 1** Press [OPERATE] to turn on the unit.
To play back a tape, turn on the TV and be sure to select the input to which the unit is connected.
- 2** Insert a prerecorded tape, then press [PLAY ▶] to begin playback.

- 3** During playback, press [PAUSE II].
Playback will be paused and sound will be muted.
- 4** Press [PLAY ▶] to resume playback.
- 5** Press [STOP ■] to stop playback.
- 6** Press [OPEN/CLOSE EJECT ▲] to eject the tape.

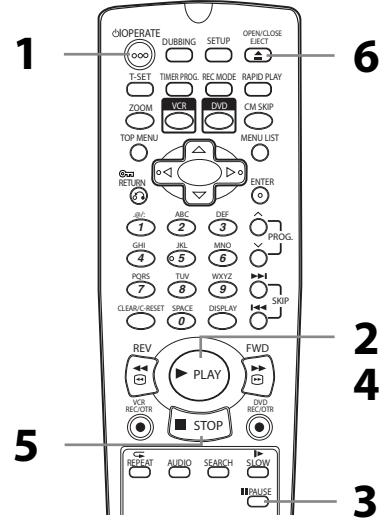

Note

- When a tape without record tab is inserted, the unit will start playback automatically.
- Tracking will be automatically adjusted upon playback. To adjust the tracking manually, press [PROG. ▲/▼].
- S-VHS videotapes are not available on this unit.

Recording and One-touch Timer Recording (OTR)

Basic Recording



- Before recording, make sure:**
- The desired channel is selected by pressing [the Number buttons] or [PROG. ▲/▼] on the remote control.
 - There is a tape with a record tab in the unit.
 - The desired recording mode is selected in SP (standard playback) or LP (long playback) mode by pressing [REC MODE] on the remote control.

Recording mode	Recording/Playback Time		
Type of tape	E60	E120	E180
SP mode	1hour	2hours	3hours
LP mode	2hours	4hours	6hours

- Refer to pages 31-35 for instructions on Timer Recording and Satellite Link.

Press first.

- 1** Turn on the unit and insert a recordable tape.
Make sure that the TV input is set on the unit.
- 2** Select the recording mode using [REC MODE].
• The desired recording mode is selected in SP (standard playback) or LP (long playback) mode by pressing [REC MODE].
- 3** Select the desired channel to record using [PROG. ▲/▼] or [the Number buttons].
- 4** Press [VCR REC/OTR ●] to start recording.
To temporarily stop recording or to resume it, press [PAUSE II]. After the unit has been in pause mode for 5 minutes, it will stop automatically to protect the tape and the video head from damage.
- 5** Press [STOP ■] when the recording is completed.

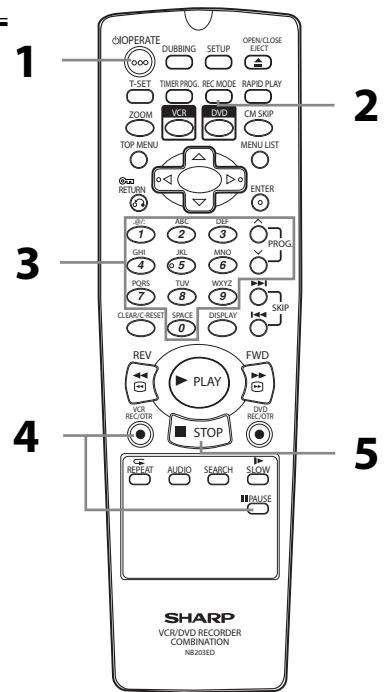

Accidental erasure prevention

To prevent accidental recording on a recorded cassette, remove its record tab. To record on it later, cover the hole with cellophane tape.

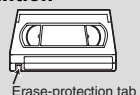

VCR functions

Recording and One-touch Timer Recording (OTR) (cont'd)

One-touch Timer Recording



This feature allows you to set the recording length simply by pressing **[VCR REC/OTR ●]**.



1

Turn on the unit and insert a recordable tape.

Make sure that the TV input is set on the unit.

2

Select the recording mode using [REC MODE]. (See page 87.)

3

Select the desired channel to record using [PROG. ^ / v] or [the Number buttons].

4

Press [VCR REC/OTR ●] repeatedly until the desired recording time (30 minutes to 8 hours) appears on the TV screen.

One-touch Timer Recording will start.

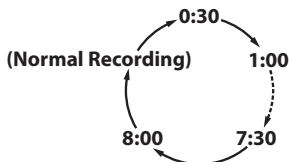

- When the unit reaches the specified time, it will be turned off automatically.
- To change the recording length during One-touch Timer Recording, press **[VCR REC/OTR ●]** repeatedly until the desired length appears.
- To cancel One-touch Timer Recording within the specified time, press **[STOP ■]**.

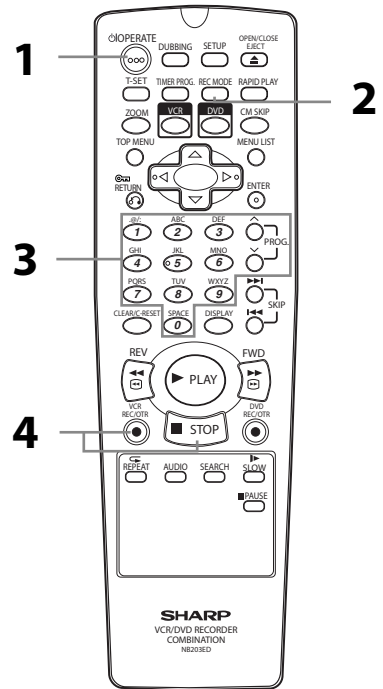

Note

- The remaining recording time will appear on the TV screen during One-touch Timer Recording. Press **[DISPLAY]** to see it on the TV screen.
- If VCR One-touch Timer Recording is completed during DVD playback or recording, the VCR will be in stop mode and the DVD keeps the current mode.
- **You cannot use the pause function during One-touch Timer Recording.**
- When One-touch Timer Recording is finished and the power is turned off, the unit will switch to the timer-standby mode automatically if a timer recording has been programmed. Press **[T-SET]** to cancel the timer-standby mode to use the unit continuously.

VCR functions

Search

Index search



Press first.

1

Press [SEARCH] so that the index search menu appears.

2

Enter the number of recordings you wish to skip using [the Number buttons] within 30 seconds.

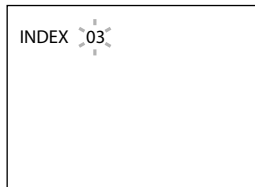

3

Press [FWD ►► / ►►] or [REV ◀◀ / ◀◀] to start index search.

If you want to go in the forward direction, press [FWD ►► / ►►]. If you want to go in the reverse direction, press [REV ◀◀ / ◀◀]. After index search, the VCR will play the tape automatically.

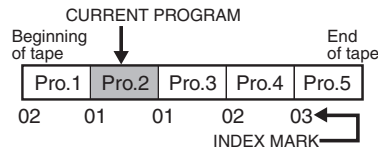

2

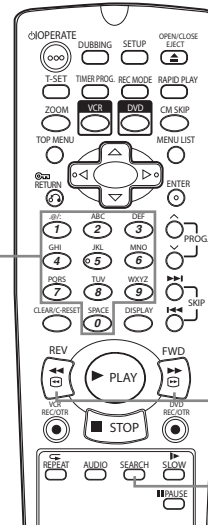

3

1

Note

- This function is not available during recording.
- Every time a tape is recorded, an index mark is written on the tape.
- You can make the index mark up to 20.

Time search



This feature allows you to go to a specific point on a tape by entering the exact amount of time you wish to skip in order to reach the point.

Press first.

1

Press [SEARCH] repeatedly so that the Time search menu appears.

2

Enter your desired time to skip using [the Number buttons] within 30 seconds.

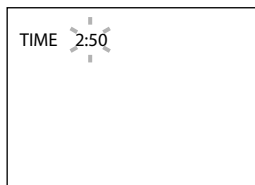

3

Press [FWD ►► / ►►] or [REV ◀◀ / ◀◀] to start time search.

If you want to go in the forward direction, press [FWD ►► / ►►]. If you want to go in the reverse direction, press [REV ◀◀ / ◀◀]. After time search, the unit will play the tape automatically.

2

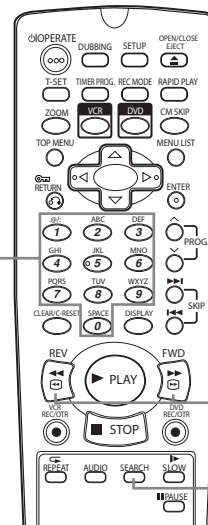

3

1

Note

- This function is not available during recording.
- Press [STOP ■] to stop the search.
- If the tape reaches the end during the search, this unit will cancel it and rewind the tape.
- You can set the time up to 9:59.

VCR functions

Other operations



To cue or review picture during playback (Picture Search):

Press [FWD ►► / ►►] or [REV ◀◀ / ◀◀] during playback.
Press it again and the unit will search in super high speed.

To freeze the picture on TV screen during playback (Still mode):

Press [PAUSE III]. Each time you press the button, the picture will be forwarded frame by frame.
If the picture begins to vibrate vertically during the still mode, stabilize the picture by pressing the [PROG. ▲ / ▼].
If the picture is distorted or rolling vertically, adjust the vertical hold control on your TV, if equipped.

Counter Reset:

Press [CLEAR/C-RESET].

To play back in slow motion:

Press [SLOW ►] during playback or the still mode.
If the noise bars appear on the TV screen, you can reduce it by pressing [PROG. ▲ / ▼].

Note

- Still / Slow / Pause mode will be automatically cancelled after 5 minutes to prevent damage to the tape and the video head.
- To return to play back from the Picture Search / Still / Slow mode, press [PLAY ►].

Hi-Fi Stereo Sound System

This unit will record and playback Hi-Fi stereo sound. In addition, it has an AV2 and NICAM stereo sound decoder.

This unit will receive stereo and bilingual broadcasts and it is possible to record in several ways and to play back the sound.

Selecting the Sound Mode

You can select each mode by pressing [AUDIO] on the remote control. Each mode is indicated on the TV screen as following.

- During playback of the recorded tape in Hi-Fi mode
- During reception of stereo broadcasts

Mode	Audio output	Display on the TV screen
Stereo	Stereo	STEREO
L	L audio from both speakers	LEFT
R	R audio from both speakers	RIGHT
Normal	Monaural	-None-

- During reception of bilingual broadcasts

Mode	Audio output	Display on the TV screen
Main	Main audio from both speakers	Main
Sub	Sub audio from both speakers	Sub
Main / Sub	• Main audio from the left speaker • Sub audio from the right speaker	Main / Sub

Note

- If you play back non-Hi-Fi tapes, the unit will play back automatically in monaural even if you select any mode.
- If the stereo signal becomes weak, the broadcast is automatically recorded in monaural.

Others

Troubleshooting

Before requesting service for this unit, check the table below for a possible cause of the problem you are experiencing. Some simple checks or a minor adjustment by you may eliminate the problem and restore correct operation.

Symptom	Remedy
VCR / DVD	
The power does not turn on.	<ul style="list-style-type: none"> • Check the mains cable is connected securely. • Check the breaker (in case of power failure).
Any of the buttons on the front panel does not function.	<ul style="list-style-type: none"> • Check if the Child Lock is activated. (See page 10.)
There is no picture.	<ul style="list-style-type: none"> • Check signal cables are connected securely. • Check if a connecting cable is damaged. • Check connections to your TV. (See pages 14-15.) • Switch the input selector on your TV (to "AV1" for example) until a picture appears on the screen.
The picture on your TV is distorted during the unit is turned on.	<ul style="list-style-type: none"> • Turn the unit off if the unit is not being used. • Change the channel on this unit.
TV programme picture does not fill the screen.	<ul style="list-style-type: none"> • Set channels with "Auto Tuning" from the Setup menu. (See page 19.) • Select the channel of a TV programme using [PROG. \wedge / \vee].
TV programme pictures are distorted.	<ul style="list-style-type: none"> • Adjust the direction of the TV antenna. • Adjust the picture. (See the TV instruction manual.) • Place the antenna and the TV farther apart. • Separate any bunched antenna cables and the TV.
TV channel cannot be changed.	<ul style="list-style-type: none"> • Switch the TV input. • Check if the antenna cable is connected correctly. (See pages 14-15.)
The channel cannot be changed from the channel you are recording.	<ul style="list-style-type: none"> • Set the TV input to "TV".
Playback picture is distorted.	<ul style="list-style-type: none"> • Do not bring equipment that may cause electrical interference, such as a cellular phone, near the unit.
The playback picture or TV programme from equipment connected through the unit is distorted.	<ul style="list-style-type: none"> • If a DVD player, VCR or tuner is connected to your TV via the unit, the copyprotection signal applied to some programmes could affect picture quality. Disconnect the playback equipment in question and connect it directly to your TV.
Nothing was recorded even though you set the timer setting correctly.	<ul style="list-style-type: none"> • There was a power failure during recording. • The unit's internal clock stopped due to a power failure that lasted for more than 1 hour. • Reset the clock. (See page 22.) • Unplug the mains cable from the AC outlet and plug it in again. • The programme contains copy protection signals that restrict copying. • The timer setting overlapped with another setting that was set later or has priority.
Timer recording is not completed or did not start from the beginning.	<ul style="list-style-type: none"> • The timer setting overlapped with another setting that has priority. (See page 33.) • There was not enough disc or tape space.
There is no sound.	<ul style="list-style-type: none"> • The disc is dirty or flawed. • Check if all cables are connected securely. • Check if a connecting cable is damaged. • Check the connections to the amplifier input. • Check if the input source setting on the amplifier is correct. • Check if the unit is in Pause mode or in Slow-motion Playback mode. • Check if the unit is in Fast Forward or Fast Reverse mode.
Timer recording is not possible.	<ul style="list-style-type: none"> • Make sure  icon appears on the front panel display of this unit. If not, press [T-SET].
The remote control does not function.	<ul style="list-style-type: none"> • Batteries are exhausted. • There are obstacles between the remote control and the unit. • The remote control is too far from the unit. • There are no batteries in the remote control. • The unit is not turned on. • The remote control is not pointed at the remote sensor on the unit. • Check if the Child Lock is activated. (See page 10.) • Press [VCR] or [DVD], whichever you need. Then, try again.

Others

Troubleshooting (cont'd)

Symptom	Remedy
VCR / DVD	
The unit does not operate correctly.	<ul style="list-style-type: none"> If static electricity or anything else causes the unit to operate abnormally, unplug the mains cable and plug it in again.
DV signal cannot be input.	<ul style="list-style-type: none"> Before connection, turn on the power supplies for both this unit and the DVC, and make sure that these units have stopped. Only a "DVC-SD" signal can be input from the DVC to this unit. Other types of signals are not supported. Do not connect any device other than the DVC. Even if a recorder or PC with another DV terminal is connected, the DV function will not operate. If the DVC is not recognized after connection, turn off the power supply for the unit and re-connect the DVC.
The DVC cannot be operated with this unit.	<ul style="list-style-type: none"> Signal input or DVC operation from this unit may be disabled depending on the type of DVC. If a DVC signal cannot be input, use an external input (AV2 / AV3) for analog connection via AV cables. DVC control may be disabled depending on the type of DVC, even in playback mode other than camera mode. In this case, switch to DVD control and execute the normal recording procedure while operating the DVC.
Certain functions of the unit cannot operate.	<ul style="list-style-type: none"> Some functions may not operate depending on the type of DVC. For example, if the DVC does not support slow playback mode, the slow playback function is disabled. With AV4 (DV input), the disc display menu does not appear unless disc playback is executed.
DV audio signal cannot be switched.	<ul style="list-style-type: none"> For recording with the DVC, the recording audio signal can be set to 12 bits or 16 bits. However, when 16-bit recording mode is selected, audio signal cannot be switched. To record an audio signal, set it to 12 bits.
DVD	
There is no picture.	<ul style="list-style-type: none"> If the Setup menu display appears, press [SETUP] or [RETURN ↶] to turn off the display.
Picture noise appears.	<ul style="list-style-type: none"> The disc is dirty or flawed. If the unit is connected to your TV via a VCR, or if it is connected to a combination TV / VIDEO player, the copy-protection signal applied to some DVD programmes could affect picture quality. If you still experience this problem even when you connect the unit directly to your TV, try connecting the unit to your TV's S-VIDEO input.
Sound is noisy.	<ul style="list-style-type: none"> The disc is dirty or flawed.
The unit does not play back the disc.	<ul style="list-style-type: none"> No disc is inserted. A blank disc is inserted. The disc is upside down. Insert the disc with the labelled side facing up. The disc is not correctly inserted. The unit cannot play back certain discs (such as a CD-ROM). (See page 42.) The region codes on the DVD-Video and the unit are not matched. (See page 42.) Moisture has condensed inside the unit. Remove the disc and leave the unit turned on for about two hours until the moisture evaporates. (See page 2.) The unit cannot play back the disc if it was recorded on another recorder and not finalised.
There is no sound.	<ul style="list-style-type: none"> If the audio signal is not output from the DIGITAL AUDIO OUT (OPTICAL / COAXIAL) jacks, check the Audio setting. (See pages 81-83.)
Playback image freezes for a moment.	<ul style="list-style-type: none"> During the playback of a two layered disc, the picture may freeze for a moment while playback switches from the first to the second layer. This is not a malfunction.
The unit does not play back the disc from the beginning.	<ul style="list-style-type: none"> Resume playback is activated. (See page 49.) Press [STOP ■] twice. You have inserted a disc whose Title menu or DVD menu automatically appears on the TV screen when it is first inserted.
The unit starts playing back the disc automatically.	<ul style="list-style-type: none"> The DVD-Video features an auto playback function.

Troubleshooting (cont'd)

Symptom	Remedy
DVD	
Some functions such as Stop, Search, or Slow-motion Playback cannot be performed.	<ul style="list-style-type: none"> Depending on the disc, you may not be able to perform some of those operations. See the instruction manual supplied with the disc.
The language for the sound track cannot be changed.	<ul style="list-style-type: none"> Multilingual tracks are not recorded on the DVD-Video, DVD-RW or DVD-R being played back. The DVD-Video prohibits the changing of the language for the sound track. Try changing the language using the DVD-Video menu.
The subtitle language cannot be changed or turned off.	<ul style="list-style-type: none"> Multilingual subtitles are not recorded on the DVD-Video. The DVD-Video prohibits changing the subtitles. Try changing the subtitles using the DVD-Video menu.
Angles cannot be changed.	<ul style="list-style-type: none"> You can change the angle only if the disc contains multi-angle scene. Angles can be changed only when the multi-angle scene appears on the screen. The DVD-Video prohibits changing angles. Try changing the angle using the DVD-Video menu.
Recording does not start immediately after pressing [DVD REC/OTR ●] .	<ul style="list-style-type: none"> An unused DVD-RW or DVD-R was inserted. It takes a while for the unit to automatically format a DVD-RW.
Recording does not stop immediately after you press [STOP ■] .	<ul style="list-style-type: none"> It will take a few seconds for the unit to send data to disc before recording can stop.
The disc tray does not open when you press [OPEN/CLOSE EJECT ▲] .	<ul style="list-style-type: none"> It may take a few seconds for the disc tray to open after you have recorded or edited a disc. This is because the unit is sending data to the disc.
"Repairing" appears on the display.	<ul style="list-style-type: none"> If a power failure occurs or the mains cable is unplugged during recording, finalising, formatting or editing (even after "Wait for a moment." message disappeared), a repairing process will begin automatically when the unit is turned on next time. It may take several minutes up to about four hours.
In a case you intend to cancel the Repairing process.	<ul style="list-style-type: none"> If you intend to cancel the Repairing process, press [OPEN/CLOSE EJECT ▲] on the front panel, then select "Yes" with [Cursor ◀ / ▶] and press [ENTER]. After that, the disc tray will automatically open. In case the Repairing process is cancelled, the disc MAY NOT work.
VCR	
Picture noise appears.	<ul style="list-style-type: none"> Adjust tracking control for better picture by pressing [PROG. ▲ / ▼] while you are playing back a video tape. Head cleaning for VCR may be necessary. Refer to "AUTO HEAD CLEANING" on page 4.
The unit does not play back the tape.	<ul style="list-style-type: none"> No video tape is inserted.
Recording does not start immediately after pressing [VCR REC/OTR ●] .	<ul style="list-style-type: none"> Make sure the video tape has a record tab when you record to a video tape. If needed, cover the hole with cellophane tape.
The remote control does not function.	<ul style="list-style-type: none"> Check if a video tape is in the unit. Press [VCR]. Then, try again. Check if the Child Lock is activated. (See page 10.)
The motor rotates even when playback / recording is stopped.	<ul style="list-style-type: none"> The motor may rotate for the duration of approximately 5 minutes for efficient operation. This is not a malfunction.

* If the above remedies do not solve the problem, please call an authorised service centre.

Others

Troubleshooting (cont'd)

Error message	Cause	Solution
Disc Error — Please eject the disc. — Playback feature may not be available on this Disc.	<ul style="list-style-type: none"> An unplayable disc is inserted in the unit. The disc is upside down. 	<ul style="list-style-type: none"> Insert a standard disc shown in "Playable discs". (See page 42.) Insert the disc with the labelled side facing up.
Region Error — Please eject the disc. — Playback is not authorised in your region.	<ul style="list-style-type: none"> Playback is not authorised in the region of the DVD-Video that you inserted in the unit. 	<ul style="list-style-type: none"> Insert a DVD-Video with region codes 4 or ALL.
Parental Lock On The current selected parental level prohibits playback.	<ul style="list-style-type: none"> The current selected parental level in the Setup menu prohibits playback. 	<ul style="list-style-type: none"> Check the "Parental Lock" setting. (See pages 85-86.)
Recording Error This programme is not allowed to be recorded.	<ul style="list-style-type: none"> The recording function encountered a copy prohibited programme. Original source is in NTSC system. 	<ul style="list-style-type: none"> You cannot record copy prohibited programmes.
Recording Error This programme is not recordable in Video mode.	<ul style="list-style-type: none"> You are trying to record a copy-once programme onto a DVD-RW disc in Video mode. 	<ul style="list-style-type: none"> Record the programme onto a DVD-RW disc in VR mode. Reformat to "VR mode". (See page 28.)
Recording Error Cannot record on this disc.	<ul style="list-style-type: none"> You are trying to record onto a disc that is unrecordable, or the disc status does not satisfy recording requirements. The disc is dirty. The disc is damaged. 	<ul style="list-style-type: none"> Insert a recordable disc, and ensure the disc status satisfies the recording requirements. (See page 24.) Clean the disc with a cleaning cloth. Replace the disc.
Recording Error This programme is not allowed to be recorded on this disc.	<ul style="list-style-type: none"> You are trying to record a copy-once programme onto a DVD-RW disc that is not compatible with CPRM. 	<ul style="list-style-type: none"> Insert a ver. 1.1 or ver. 1.2 DVD-RW disc (compatible with CPRM).
Recording Error This disc is protected and not recordable.	<ul style="list-style-type: none"> You are trying to record onto a disc that is set as protected in the Setup menu. 	<ul style="list-style-type: none"> Remove the disc protect setting in the Setup menu. (See page 40.)
Recording Error Disc is full. (No area for new recording)	<ul style="list-style-type: none"> You are trying to record onto a disc that has no space for recording. 	<ul style="list-style-type: none"> Insert a recordable disc with enough recording space. Delete unnecessary original titles. (See page 64.)
Recording Error You cannot record more than 99 titles on one disc. (The maximum is 99)	<ul style="list-style-type: none"> You are trying to record onto a disc on which the number of recorded titles has reached the maximum (99). 	<ul style="list-style-type: none"> Delete unnecessary original titles. (See page 64.)
Recording Error You cannot record more than 999 chapters on one disc. (The maximum is 999)	<ul style="list-style-type: none"> You are trying to record onto a disc on which the number of recorded chapters has reached the maximum (999). 	<ul style="list-style-type: none"> Delete unnecessary chapter mark from an Original list. (See pages 67-68, 77.)
Recording Error You cannot record on this disc as Control Information is full.	<ul style="list-style-type: none"> This disc has no space to write Control Information when recording or deleting contents. When editing has been repeatedly performed, the control information area may become full even though the recording area has enough space. 	<ul style="list-style-type: none"> Delete unnecessary titles. (See page 64.)
Recording Error You cannot record on this disc as Power Calibration Area is full.	<ul style="list-style-type: none"> When recordings are performed repeatedly onto an unstable disc, this area may become full. Every time you insert a disc for recording, part of the disc's working area will be used. If you repeat these frequently, it will be used up quicker and you may not be able to record full 99 titles. 	<ul style="list-style-type: none"> Insert a new disc.
Recording Error This disc is already finalised.	<ul style="list-style-type: none"> You are trying to record onto a disc that is already finalised. 	<ul style="list-style-type: none"> Release the finalising for the disc. (See pages 40-41.)

* If you are still having trouble with the unit after checking all the Troubleshooting points, write down the error code and the error description and consult your dealer or an authorised service centre.

Others

Language code

Language	Code	Language	Code	Language	Code
Abkhazian	4748	Hungarian	5467	Russian	6467
Afar	4747	Icelandic	5565	Samoaan	6559
Afrikaans	4752	Indonesian	5560	Sangho	6553
Albanian	6563	Interlingua	5547	Sanskrit	6547
Amharic	4759	Interlingue	5551	Scots Gaelic	5350
Arabic	4764	Inupiak	5557	Serbian	6564
Armenian	5471	Irish	5347	Serbo-Croatian	6554
Assamese	4765	Italian	5566	Sesotho	6566
Aymara	4771	Japanese	5647	Setswana	6660
Azerbaijani	4772	Javanese	5669	Shona	6560
Bashkir	4847	Kannada	5760	Sindhi	6550
Basque	5167	Kashmiri	5765	Singhalese	6555
Bengali; Bangla	4860	Kazakh	5757	Siswat	6565
Bhutani	5072	Kinyarwanda	6469	Slovak	6557
Bihari	4854	Kirghiz	5771	Slovenian	6558
Bislama	4855	Kirundi	6460	Somali	6561
Breton	4864	Korean	5761	Spanish	5165
Bulgarian	4853	Kurdish	5767	Sundanese	6567
Burmese	5971	Laothian	5861	Swahili	6569
Byelorussian	4851	Latin	5847	Swedish	6568
Cambodian	5759	Latvian; Lettish	5868	Tagalog	6658
Catalan	4947	Lingala	5860	Tajik	6653
Chinese	7254	Lithuanian	5866	Tamil	6647
Corsican	4961	Macedonian	5957	Tatar	6666
Croatian	5464	Malagasy	5953	Telugu	6651
Czech	4965	Malay	5965	Thai	6654
Danish	5047	Malayalam	5958	Tibetan	4861
Dutch	6058	Maltese	5966	Tigrinya	6655
English	5160	Maori	5955	Tonga	6661
Esperanto	5161	Marathi	5964	Tsonga	6665
Estonian	5166	Moldavian	5961	Turkish	6664
Faroese	5261	Mongolian	5960	Turkmen	6657
Fiji	5256	Nauru	6047	Twi	6669
Finnish	5255	Nepali	6051	Ukrainian	6757
French	5264	Norwegian	6061	Urdu	6764
Frisian	5271	Occitan	6149	Uzbek	6772
Galician	5358	Oriya	6164	Vietnamese	6855
Georgian	5747	Oromo (Afan)	6159	Volapuk	6861
German	5051	Panjabi	6247	Welsh	4971
Greek	5158	Pashto; Pushto	6265	Wolof	6961
Greenlandic	5758	Persian	5247	Xhosa	7054
Guarani	5360	Polish	6258	Yiddish	5655
Gujarati	5367	Portuguese	6266	Yoruba	7161
Hausa	5447	Quechua	6367	Zulu	7267
Hebrew	5569	Rhaeto-Romance	6459		
Hindi	5455	Romanian	6461		

Analogue audio

An electrical signal that directly represents sound. In contrast, digital audio can also be an electrical signal, but is an indirect representation of sound. See also Digital audio.

Aspect ratio

The width of a TV screen relative to its height. Conventional TVs are 4:3 (i.e., the screen is almost square). Widescreen models are 16:9 (the screen is almost twice as wide as its height).

Chapter

Just as a book is split up into several chapters, a title on a DVD disc is usually divided into chapters. See also Title.

CM SKIP

This unit can skip TV commercials during DVD Video playback. Once **[CM SKIP]** is pressed, the start point will be set forward 30 seconds and playback resume automatically. (You can press **[CM SKIP]** up to 6 times.)

CPRM

(Content Protection for Recordable Media)

CPRM is a scrambling copy protection system for the protection of "copy-once" broadcast programmes (e.g. some satellite broadcasts).

Digital audio

An indirect representation of sound using numbers. During recording, the sound is measured at discrete intervals (44 or 100 times a second for CD audio) by an analogue-to-digital converter, generating a stream of numbers. On playback, a digital-to-analogue converter generates an analogue signal based on these numbers. See also Sampling frequency and Analogue audio.

Dolby Digital

A system developed by Dolby Laboratories that compresses digital sound. It works with stereo (2ch) or multi-channel audio.

DTS

(Digital Theater System)

DTS is a Multi-channel surround sound system, but it is different from Dolby Digital. Both formats were developed by Digital Theater Systems, Inc.

Finalise

To make DVDs that have been recorded playable in DVD players. It is possible to finalise DVD-RW/-R discs with this unit.

JPEG

(Joint Photographic Experts Group)

JPEG is a method of compressing still image files. You can copy JPEG files on CD-RW/-R discs from a computer and play back the files on this unit.

MP3

(MPEG Audio Layer 3)

MP3 is a method of compressing files. You can copy MP3 files on CD-RW/-R discs from a computer and play back the files on this unit.

PBC (Video CD only)

(Playback Control)

This function enables you to play back interactive software using a menu screen. See also Title.

PCM

(Pulse Code Modulation)

PCM is a format that converts audio into digital data. It is mainly used for Audio CDs and DAT. This unit can play back sounds as realistic as possible by converting even compressed Dolby Digital and MPEG audio to PCM.

Playlist

From this list you can play back contents of a disc in your desired order or in sequence. It is also possible to directly search for a specific scene.

Region code

Regions associate discs and players with particular areas of the world. This unit will only play back discs that have compatible region codes. You can find the region code of your unit by looking on the rear panel. Some discs are compatible with more than one region (or all regions).

Sampling frequency

The rate at which sound is measured by a specified interval to turn it into digital audio data. The number of samples in one second is defined as the sampling frequency. The higher the rate is, the better the possible sound quality.

S-Video output

Video is output as the individual signals of colour(C) and luminance(Y), so a higher-quality picture will be displayed.

Title

(DVD)

A collection of chapters on a DVD. See also chapter.

(Video CD)

The contents of a Video CD. When playing back a Video CD with the PBC function, the Title menu will appear automatically.

Track

Audio CDs and Video CDs use tracks to divide the contents of a disc. The DVD equivalent is called a chapter. See also Chapter.

Others

Specifications

General

System	DVD-Video, DVD-RW/-R, DVD+RW/+R, CD-DA, CD-RW/-R VHS Video Cassette Tape
VCR video heads	Four heads
Power requirements	230–240V ~ ± 10%, 50Hz ± 0.5%
Power consumption	35W (standby: 5.0W)
Weight	4.4kg
Dimensions (width x height x depth)	435 x 99.5 x 261mm
Operating temperature	5°C to 40°C
Operating humidity	Less than 80% (no condensation)
TV format	PAL B/G

Recording

Recording format	Video Recording format (DVD-RW only), Video format (DVD-RW, DVD-R)
Recording discs	DVD-ReWritable, DVD-Recordable

Video recording format

Sampling frequency	13.5MHz
Compression format	MPEG

Audio recording format

Sampling frequency	48kHz
Compression format	Dolby Digital

Tuner

Receivable channels

E2-E69

Note

- The specifications and design of this product are subject to change without notice.

Before you start

Connections

Getting started

Recording

Disc Playback

Editing

Changing the
Setup menu

VCR functions

Others

SHARP

FOR LOCATION ENQUIRIES WITHIN

AUSTRALIA

REGARDING YOUR LOCAL

SHARP APPROVED SERVICE CENTRE

VISIT OUR WEBSITE AT

www.sharp.net.au

OR CALL SHARP CUSTOMER CARE

1300 135 022

(LOCAL CALL COST APPLY WITHIN AUSTRALIA)

SHARP CORPORATION OF AUSTRALIA PTY LTD

SHARP

FOR LOCATION ENQUIRIES WITHIN

NEW ZEALAND

REGARDING YOUR LOCAL

SHARP APPROVED SERVICE CENTRE

VISIT OUR WEBSITE AT

www.sharp.net.nz

CONTACT YOUR SELLING DEALER/RETAILER

OR CALL

SHARP CUSTOMER SERVICES

TELEPHONE: 09 573 0111

FACSIMILE: 09 573 0113

SHARP CORPORATION OF NEW ZEALAND LIMITED

SHARP

WARRANTY

Consumer Electronic Products

Congratulations on Your Purchase!

This Sharp product is warranted against faults in materials and manufacture for a period of twelve (12) months from the date of original purchase.

If service is required during the warranty period, please contact your nearest Sharp Approved Service Centre. These repairs would be carried out at no charge to the owner, subject to the conditions specified herein.

The owner is responsible for any transportation and insurance costs if the product has to be returned for repair.

This warranty does not extend to accessories or defects or injuries caused by or resulting from causes not attributable to faulty parts or the manufacture of the product, including but not limited to, defect or injury caused by or resulting from misuse, abuse, neglect, accidental damage, improper voltage, liquid spillage, vermin infestation, software, or any alterations made to the product which are not authorised by Sharp.

Please retain your sales documentation, as this should be produced to validate a warranty claim.

This warranty is in addition to and in no way limits, varies or excludes any express and implied rights and remedies under any relevant legislation in the country of sale.

IMPORTANT DO NOT RETURN THIS DOCUMENT TO SHARP

For your reference, please enter the particulars of your purchase below and retain, with your purchase documentation.

Model No. _____

Serial No. _____

Date of Purchase _____

Retailer _____

SHARP
SHARP CORPORATION OF AUSTRALIA PTY. LIMITED
ABN 40 008 038 408
1 Hummingwood Drive
Hummingwood NSW 2148
SHARP CORPORATION OF NEW ZEALAND LIMITED
59 Hugo Johnston Drive
Penrose, Auckland
SPForm200 (JUNE 2004)

IMPORTANT NOTICE: This warranty applies only to products sold in Australia & New Zealand